

MOUNTING AND INSTRUCTION MANUAL

Net Master Clock

DTS 4801.masterclock
DTS 4802.masterclock
DTS 4803.masterclock
DTS 4806.masterclock

Network Timeserver and Master Clock



Certification of the Producer

STANDARDS

The DTS 4801.masterclock, DTS.4802 masterclock, DTS 4803.masterclock and DTS 4806.masterclock were developed and produced in accordance with the EU Guidelines:

2014 / 30 / EU	EMC
2014 / 35 / EU	LVD
2008 / 57 / EU	Railway
2011 / 65 / EU	RoHS
1907 / 2006	REACH
2012/19/EU	WEEE



CB Test Certification (IEC 60950-1):

DTS 4801 / DTS 4802



CB Test Certification (IEC 62368-1):

DTS 4806

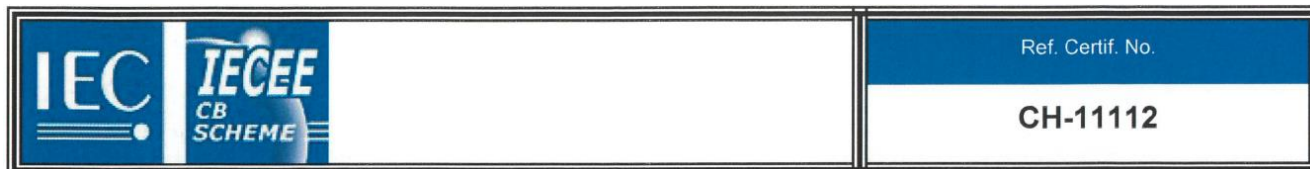

References to the Instruction Manual

1. The information in this Instruction Manual can be changed at any time without notice. The current version is available for download at www.mobatime.com.
2. The device software is continuously being optimized and supplemented with new options. For this reason, the newest software version can be obtained from the Mobatime website.
3. This Instruction Manual has been composed with the utmost care, in order to explain all details in respect of the operation of the product. Should you, however, have any questions or discover any errors in this Manual, please contact us.
4. We are not liable for any direct or indirect damages which could occur when using this Manual.
5. Please read the instructions carefully and only use the product, after you have correctly understood all the information for installation and operation.
6. The installation must only be carried out by skilled staff.
7. It is prohibited to reproduce, store in a computer system, or transfer this publication, or any part of it in any way. The copyright remains with all the rights with BÜRK MOBATIME GmbH, D-78026 VS-Schwenningen and MOSER-BAER AG – CH 3454 Sumiswald / SWITZERLAND.

Overview

1	Safety	6
2	Maintenance	9
3	General Information: Introduction.....	10
4	Displays	14
5	Installation	16
6	Operation.....	18
7	Power supply and voltage monitoring	71
8	Updates	73
9	Time administration	80
10	SNMP	88
11	Description of the switch function.....	95

ANNEX

A	Connection diagrams.....	97
B	Time Zone Table.....	102
C	Alarm List	104
D	Troubleshooting	106
E	Serial Telegrams.....	107
F	Copyright Notice	113
G	Block diagram.....	114
H	Technical data	115
I	Index.....	119
J	Connection Table (to be filled-in)	121

|

Table of contents

1	Safety	6	6.5.12	Time handling	48
1.1	Safety instructions	6	6.5.13	General time configuration	49
1.2	Symbols and Signal Words used in this Instruction Manual	6	6.5.14	Time source	50
1.3	Intended Use	6	6.5.15	NTP server	51
1.4	Observe operating safety!	7	6.5.16	Communication Alarm Network (CAN) to MTC	55
1.5	Consider the installation site!	7	6.5.17	Manual time set	55
1.6	Please observe the electromagnetic compatibility!	7	6.5.18	Alarms	56
1.7	Network security	7	6.5.19	Alarm relays	56
1.8	Pay attention to the instructions for the connection of the power supply	8	6.5.20	Alarm mask	56
2	Maintenance	9	6.5.21	E-mail	57
2.1	Troubleshooting: Repairs	9	6.5.22	SNMP-Traps	59
2.2	Cleaning	9	6.5.23	General settings	60
2.3	Disposing	9	6.5.24	Network	61
3	General Information: Introduction	10	6.5.25	Services (network services FTP, telnet, SSH...)	63
3.1	Scope of Delivery	10	6.5.26	SNMP	64
3.2	Technical Data	10	6.5.27	SNMP V1 / V2c	65
3.3	Device Description in this Manual	10	6.5.28	SNMP V3	66
3.4	Device Description	10	6.5.29	Time zone selection	68
3.5	Device types	11	6.5.30	System voltage (DTS 4806)	69
3.6	DTS Distributed Time System	12	6.6	Maintenance menu	70
3.7	MOBA-NMS - Network Management System	12	7	Power supply and voltage monitoring	71
3.7.1	Overview of the main functions	13	7.1	Connection methods	71
3.7.2	Device management	13	7.2	Power reserve battery (DTS 4806)	71
4	Displays	14	7.3	System voltage (DTS 4806)	71
4.1	LED displays front view	14	7.3.1	System voltage configuration	71
4.2	LED displays rear view	14	7.3.2	System voltage monitoring (DTS 4806)	72
4.3	Display	15	8	Updates	73
5	Installation	16	8.1	Image and file names	73
5.1	Connections	16	8.2	Updating images with MOBA-NMS	73
5.2	Boot procedure of the DTS 480x.masterclock	16	8.3	Updating images via FTP	74
5.3	Firmware	16	8.4	Updating applications or configurations via FTP	74
5.4	Basic settings (factory settings)	17	8.5	Updating images via USB	75
6	Operation	18	8.6	Updating applications or configurations via USB	76
6.1	General	18	8.7	FTP connection	77
6.1.1	Serial connection	19	8.8	SFTP Connection	77
6.1.2	Telnet	19	8.9	SCP Connection	78
6.1.3	SSH	19	8.10	Save configuration externally	78
6.1.4	Menu structure	20	8.11	Copying Telegram or Program files to the DTS 480x.masterclock	79
6.2	MOBA-NMS operation	21	9	Time administration	80
6.3	Main menu	22	9.1	Concept of time administration	80
6.4	Status menu	23	9.2	Overview of NTP	81
6.4.1	Time information and status	24	9.3	Fix stratum for local time source synchronizing multicast clocks	81
6.4.2	Time source information	25	9.4	Configuration and Use Cases	82
6.5	Configuration menu	26	9.4.1	DCF/GPS with NTP	82
6.5.1	Lines	27	9.4.2	DCF/GPS without NTP	82
6.5.2	MOBALine	28	9.4.3	Off with NTP (standard NTP server RFC 5905)	83
6.5.3	Impulse line	30	9.4.4	Internal with NTP	83
6.5.4	IRIG-B, AFNOR (DTS 4803 only)	32	9.4.5	Internal without NTP	84
6.5.5	DCF active code line	33	9.5	Time take over	84
6.5.6	Combined DCF-Impulse line	35	9.6	Time server	85
6.5.7	DCF / Pulse output	37	9.7	Time accuracy, time-keeping	85
6.5.8	Serial telegrams	38	9.8	Leap second	85
6.5.9	RS 485 Clock line	39	9.9	NTP Authentication	85
6.5.10	NTP slave clocks / Time zone server	42	9.9.1	NTP symmetric keys	85
6.5.11	Switch function / Switch program	44	9.9.2	NTP Autokey	87
			10	SNMP	88

10.1	General.....	88	E.2	Syntax of the telegram configuration file	109
10.2	Device configuration with SNMP	89	F	Copyright Notice	113
10.3	DTS Subagent SNMP Notification	89	G	Block diagram.....	114
10.3.1	Startup [dts480xStartUp]	89	H	Technical data	115
10.3.2	Shutdown [dts480xShutdown]	89	I	Index	119
10.3.3	Status changed [dts480xStatusChanged]	90	J	Connection Table (to be filled-in)	121
10.3.4	Configuration changed [dts480xConfigChanged]	90			
10.3.5	Alive Notification [dts480xAlive]	94			
10.3.6	Alarm Notification [dts480xAlarm]	94			
11	Description of the switch function	95			
11.1	General Description	95			
11.2	Combination of the signals	96			
11.3	Behavior at start-up, exchange of switch program file	96			
ANNEX					
A	Connection diagrams	97			
A.1	Front connections.....	97			
A.2	Connections (rear view) DTS 4801.masterclock & DTS 4803.masterclock	98			
A.3	Connections (rear view) DTS 4802.masterclock	99			
A.4	Connections (rear view) DTS 4806.masterclock	100			
A.5	Plug-in spring terminals.....	101			
A.6	Connection of GNSS / GPS 4500, DCF 450 / 4500 or GNSS 3000	101			
B	Time Zone Table	102			
C	Alarm List	104			
C.1	Alarms	104			
D	Troubleshooting.....	106			
E	Serial Telegrams	107			
E.1	General.....	107			

1 Safety



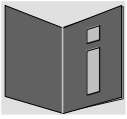

1.1 Safety instructions



Read this chapter and the entire instruction manual carefully and follow all instructions listed. This is your assurance for dependable operations and a long life of the device.

Keep this instruction manual in a safe place to have it handy every time you need it.

1.2 Symbols and Signal Words used in this Instruction Manual

	Danger! Please observe this safety message to avoid electrical shock! There is danger to life!
	Warning! Please observe this safety message to avoid bodily harm and injuries!
	Caution! Please observe this safety message to avoid damages to property and devices!
	Notice! Additional information for the use of the device.
	Important information in the Manual! This information must be followed!

1.3 Intended Use

The **DTS 480x.masterclock** is a master clock for the use in network environments. It can be synchronized from NTP and be used as NTP server. In addition, it can read the time from DCF or GPS (e.g. from GPS 4500).

It can operate as master clock for a self-setting MOBALine clock line (with switching function e.g. for clock illumination, switching program and for world time function) or it can drive a line of impulse clocks or DCF active code clocks. The DTS 4802 has 2, the DTS 4806 6 such lines.

DTS 4803 has 1 MOBALine/Impulse clock line (like 4801) and 1 IRIG-B clock line.

For additional functions, see the device descriptions in Chapter 3.4.

The device is designed for 19" racks and intended to be installed in a 19" cabinet. Operate the device only in installed condition and with all connectors plugged in.

Use this product only as stated in this instruction manual. Any other use is considered improper use.



Caution!

1.4 Observe operating safety!

- Never open the housing of the device! This could cause an electric short or even a fire, which would damage your device. Do not modify your device!
- The device is not intended for use by persons (including children) with limited physical, sensory, or mental capacities or a lack of experience and/or knowledge.
- Keep packaging such as plastic films away from children. There is the risk of suffocation if misused.



Caution!

1.5 Consider the installation site!

- To avoid any operating problems, keep the device away from moisture and avoid dust, heat, and direct sunlight. Do not use the device outdoors.
- The device is designed for 19" racks and should only be operated installed in a 19" rack.
- Take care to provide sufficient fresh air for the device.
- The louvers must not be closed or blocked (DTS 4806).
- Never install the devices in a completely closed rack. Otherwise the produced warm air in the rack cannot escape and the devices cannot be cooled.



Danger! Make sure

that you wait before using the device after any transport until the device has reached the ambient air temperature. Great fluctuations in temperature or humidity may lead to moisture within the device caused by condensation, which can cause a short.



Caution!

1.6 Please observe the electromagnetic compatibility!

- This device complies with the requirements of the EMC and the Low-voltage Directive.



Caution!

1.7 Network security

- The default password shall be changed after the commissioning of the device.
- A reset of the password to default through hardware is not possible. Using MOBA-NMS the password can be modified. In case an access via MOBA-NMS is not possible, support effort will be needed or the device has to be sent back to the factory.
- All unused services shall be deactivated: FTP, Telnet,...
- Refer to our Security Guidelines TE-801312 (see www.mobatime.com – Login area: > Customer_area > Product_Resources - 10_Timerserver_TimeCenter).

1.8 Pay attention to the instructions for the connection of the power supply

The connections are described in appendix "A Connection diagrams".



Danger! Absolutely pay attention:

Mounting, installation, commissioning and repairs of electrical devices must only be carried out by a licensed electrician. While the national installation regulations must be adhered.



For each power supply connection (**Mains**) / (**DC In**) / (**Bat In**) two fuses of 10A (13A) slow has to be provided (in both lines).

The used fuses for the DC- and battery supply have to be approved for DC.

Each power supply connection (**Mains**) / (**DC In**) / (**Bat In**) needs to be realized with an all-pole disconnection device, which is installed near to the device mentioned in this manual, which is clearly labeled and good accessible.



When the device is powered via DC, you first must connect the **protective earth (PE)**. The protective earth shall be wired with a yellow-green cable of at least 1.5mm² cross section to the specially labeled PE connection point.

The DC power supply shall not be connected, before the protective earth (PE) is correctly connected.

Before working on a device or on the electrical installations the corresponding circuits have to be switched off and secured against uncontrolled power on.

In case more than one supply voltage is used, including battery power supply, all of them have to be disconnected before starting any maintenance work.

2 Maintenance

2.1 Troubleshooting: Repairs

Please read carefully Appendix "D Troubleshooting" if your device does not work properly.

If you cannot rectify the problems, contact your supplier from whom you have purchased the device.

Any repairs must be carried out at the manufacturer's plant.

Disconnect the power supply immediately and contact your supplier, if ...

- liquid has entered your device
- the device does not properly work and you cannot rectify this problem yourself.

2.2 Cleaning

- Please make sure that the device remains clean especially in the area of the connections, the control elements, and the display elements.
- Clean your device with a damp cloth only.
- Do not use solvents, caustic, or gaseous cleaning substances.

2.3 Disposing



Device

At the end of its lifecycle, do not dispose of your device in the regular household rubbish. Return your device to your supplier who will dispose of it correctly.



Packaging

Your device is packaged to protect it from damages during transport.

Packaging is made of materials that can be disposed of in an environmentally friendly manner and properly recycled.

3 General Information: Introduction

3.1 Scope of Delivery

Please check your delivery for completeness and notify your supplier within 14 days upon receipt of the shipment, if it is incomplete.

The package you received contains:

- DTS 480x.masterclock
- Mounting set for rack mounting consisting of:
 - 4 pcs nuts for 19" housing
 - 4 screws M6 for the nuts
 - 4 plastic discs for screws M6
- Connector set
 - plug 3-pole black for power supply

DTS 4801 / DTS 4802 / 4803

- 1x spring terminal 12-pole orange
- 1x spring terminal 8-pole orange
- 1x spring terminal 5-pole orange
- 1x spring terminal 2-pole orange

DTS 4806

- 2x spring terminal 6-pole orange
- 1x spring terminal 3-pole orange
- 9x spring terminal 2-pole orange

- 2 pcs mounting tools with spring terminals

3.2 Technical Data

See Appendix H Technical data.

3.3 Device Description in this Manual

This instruction manual is for the master clocks **DTS 4801.masterclock**, **DTS 4802.masterclock**, **DTS 4803.masterclock** and **DTS 4806.masterclock**. Below all models will be referred to as the **DTS 480x.masterclock** and only as 4801, 4802, 4803 or 4806 with regard to the special features of the individual models.

3.4 Device Description

The **DTS 480x.masterclock** is a master clock for use in network environments. It can be synchronized both from NTP and also function as an NTP server. In addition, it can import the time from DCF or from GPS (e.g. from GPS 4500).

As a master clock, it can supply a self-adjusting MOBALine clock line (with switch function for clock illumination, switch program and world time function) or alternatively to the MOBALine clock line, a line can also be operated with impulse clocks or DCF active code clocks. The DTS 4802 is equipped with two such lines, the DTS 4806 with six.

Additionally it can generate serial telegrams and output them via RS 485 (only DTS 4801) or RS 232.

The DTS 4806 can additionally operate using a power reserve battery monitored by the DTS 4806. The DTS 4806 Extended can operate all impulse line types (24V, 48V, 60V).

With one device, mixed operation can be realized (e.g. line1: impulse line 60V, line2: MOBALine, line3: impulse line 24V).

The DTS 480x can supply NTP clocks with NTP and time zone tables using multicast.

As the "Main" master clock, it can synchronize other master clocks or other equipment with DCF and monitor with 4 alarm inputs. As an option to DCF, synchronization pulses can also be generated.

The DTS 480x can send both e-mails and SNMP traps for alerting purposes.

Using SNMP, configuration and system status can be requested and the DTS 480x operated.

The DTS 480x can be connected as a master clock to a MTC CAN module which can monitor and synchronize up to 16 master clocks.

As part of the DTS system, it functions as a master clock or clock line.

3.5 Device types

Model:	Characteristics:	Product no.:
DTS 4801.masterclock	According to the description above 1 clock line MOBALine/impulse 24V/ DCF active code 1 RS 485 clock line	117984
<i>Discontinued!</i> DTS 4801.masterclock IRIG-B	This model has been replaced by the DTS 4803.masterclock. Please consult user manual Rev. 17 or older. Like DTS 4801, additional with IRIG-B / AFNOR / DCF-FSK – line (built in IF 488 interface)	117985
DTS 4802.masterclock	According to the description above 2 clock lines MOBALine/impulse 24V/ DCF active code no RS 485 clock line	117987
DTS 4803.masterclock	Like DTS 4801, additional with IRIG-B / AFNOR – clock line	133688
DTS 4806.masterclock Standard	According to the description above 6 clock lines MOBALine/impulse 24V/ DCF active code no RS 485 clock line	123746
DTS 4806.masterclock Extended	According to the description above 6 clock lines MOBALine/impulse 24/48/60V/ DCF active code no RS 485 clock line	124808

3.6 DTS Distributed Time System

The DTS (Distributed Time System) is a system developed by the company Moser-Baer AG to link decentralized main clocks, slave clock lines, and time servers. The LAN (Ethernet) is used as connection. The DTS can be centrally operated and monitored.

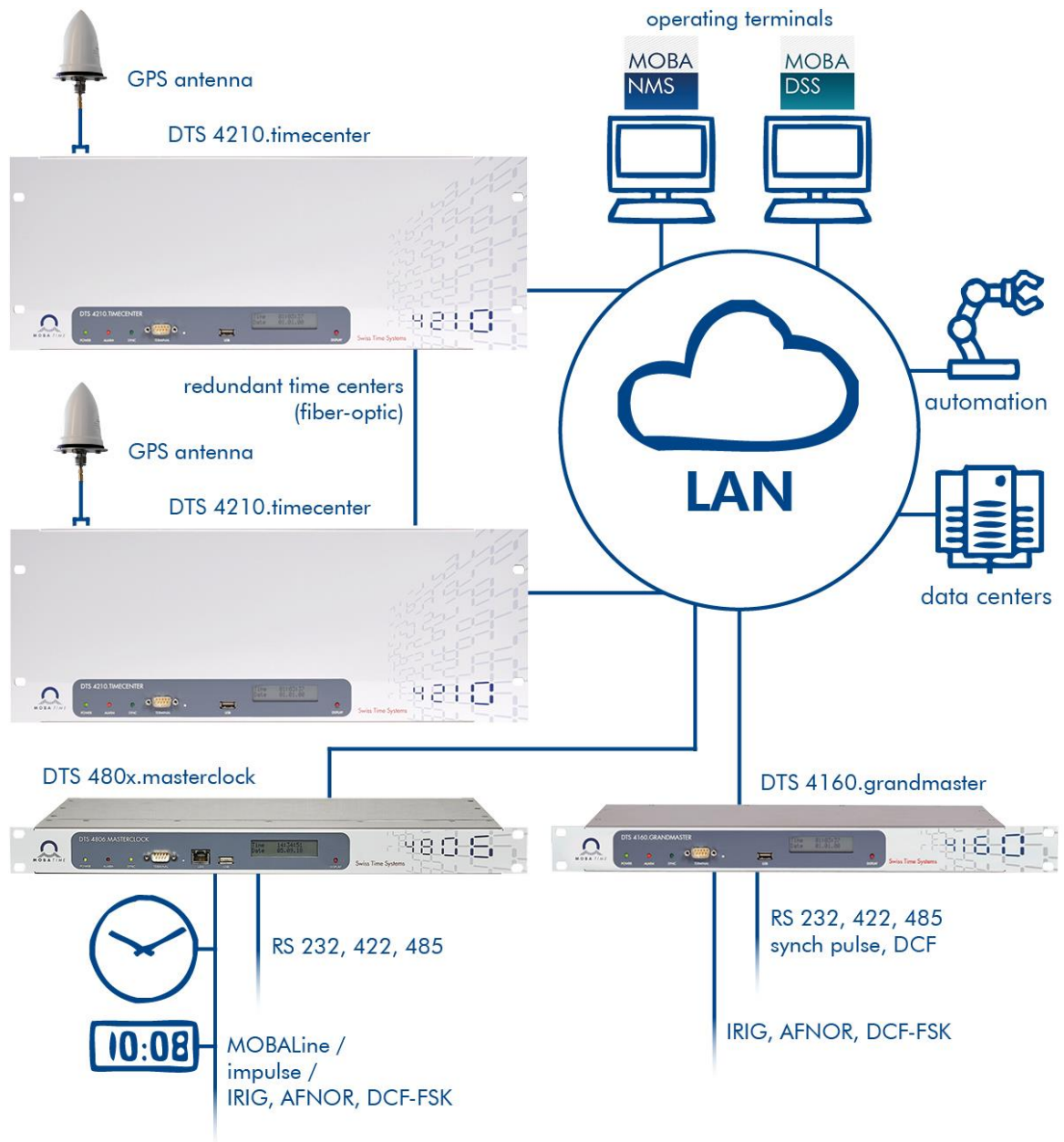

3.7 MOBA-NMS - Network Management System

MOBA-NMS is software used for central management and inquiry of state and alarm information. It supports DTS devices as well as all MOBATime analog and digital network clocks and can handle a network with more than 1000 devices. This software provides extensive functions for the configuration, installation, back-up / recovery etc. especially for DTS devices.

True to the DTS concept, MOBA-NMS can be installed multiple times in one network. With different user rights on the device and software level, the configuration abilities of different users can be set as required.

For DTS devices, all communication is conducted using SNMP V3. The SFTP protocol is used for transmitting files.

3.7.1 Overview of the main functions

The main MOBA-NMS functions for DTS devices and network clocks are listed below:

- automatic device scan over multicast or IP range
- device management using user-defined device groups → see chapter „3.7.2 Device management“
- intuitive user interface with input check for the device configuration
- status / alarm request and display on the device group level
- device firmware update for one or several devices (parallel)
- support for device commands, e. g. reset, restart etc.
- back-up / recovery of DTS devices
- transfer of the whole DTS configuration to another device
- user management with different access rights
- monitor for NTP and time zone packages
- editor for time zone files
- online help
- etc.

3.7.2 Device management

All MOBATime network devices are displayed in the so-called device view. Here, the devices can be grouped according to user-defined criteria. For this, the individual devices can simply be moved to the according groups and sorted using drag and drop. There is no limit to the number of groups and sub-groups.

Besides the organizational advantages (easier locating, better overview), a device group has the following advantages:

- commands and device updates can be applied to the whole group (including sub-groups).
- Alarms and errors of included devices are displayed on the group level.
- Complete groups can be moved / sorted among themselves.

The content of the device view can be saved and opened at a later time. The created structure and breakdown into groups is preserved.

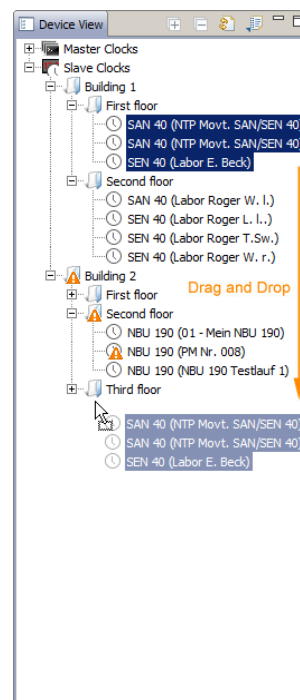

4 Displays

4.1 LED displays front view



Description	Color	Status	Description
power	Green	On Off	Mains or DC power supply is connected No power supply
alarm	Red	On Off	The alarm relay signalizes an alarm No active alarms
sync	Green	On Flashing Off	DTS 480x masterclock can read the time from a synchronization source Time source internally (RTC) or manual time setting (flashing till "NTP synch. Lost" alarm appears or an external time source is available after restart) Synchronization source is not available. Off when alarm "Failure time source Str" occurs. See chapter 6.5.13, menu 1: "Stratum limit for synchalarm". For DCF time source the delay for this alarm is defined in chapter 6.5.14, menu 7: "Stratum TO (0-16) DCF/GPS fail".
LAN control lamps:			
Left	Green Orange	Blinking Blinking	Network activity No connection to network
Right	Yellow	Off On	10 Mbit 100 Mbit

4.2 LED displays rear view

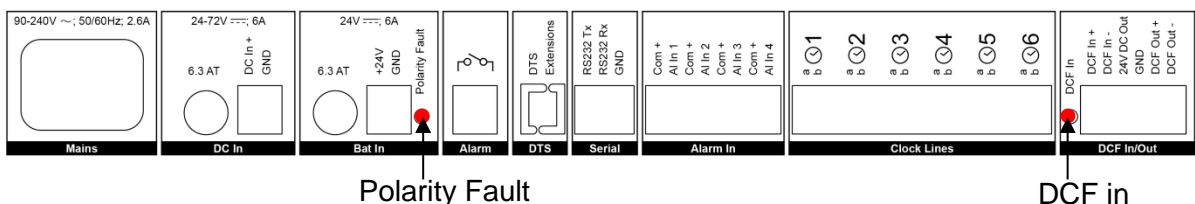

Description	Color	Status	Description	Devices
DCF in	red	blinking	DCF (GPS reception)	all devices
Polarity Fault	red	on	battery Polarity (error)	DTS 4806

4.3 Display

Display showing the current status of the DTS 480x.

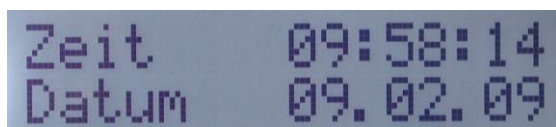

Display of:

- Time, date
- Current time source
- Stratum of the DTS 480x.masterclock
- Line time of MOBALine / Impulse lines
- Software-Version
- IPv4 address
- IPv6 address
- System voltage (DTS 4806 only)
- Alarm summary
- Current alarms

The display can be operated by means of the corresponding "Display" button:

First press the button briefly:	Switch on the background light
Other buttons to press briefly:	Scroll through all displays
Press button longer (>3 sec):	Change to default display (time and date)

The display changes after approx. 3 min without pressing the button for the default display and the background light goes off.

If a USB stick has been plugged in, it will be displayed. Should only telegram and/or program files be copied, this can be activated directly with the button. (Press the button until the copy process starts).

5 Installation

5.1 Connections

The connections are specified in Appendix "A Connection diagrams".

Only connect the designated devices to the various inputs and outputs.

Please take care to security instructions in chapter 1.

5.2 Boot procedure of the DTS 480x.masterclock

The normal booting time of the DTS 480x is approx. 20 sec. with pre-set IP or with DHCP. The booting procedure of the operating system is displayed on the serial console. After that, the text "starting" appears on the display (during the booting procedure the display is dark and empty). Without connection to a DHCP server, the first start up can take up to 30 seconds. After that, the DHCP option must be set to "off" in the network configuration.

The display "starting" remains until the time of output to the lines.

The duration, depending on the configuration, is 2-20 sec.

5.3 Firmware

It is recommended to install the current firmware on your device prior to the definite commissioning. The current firmware can be found under www.mobatime.com > Support > Product Resources (e.g. enter 4801 in search field).

5.4 Basic settings (factory settings)

General	Internal time zone	MEZ
	Menu password	dts
	Language	English
Time source	Source	DCF-GPS (UTC)
	Stratum	auto
	Error stratum	5
	DCF timeout	off
	DCF correction	0ms
	Offset per Stratum	50ms
Lines	Synch only offset	off
	DCF output	on, UTC
	Lines 1 to 6	off, MOBALine, CET
	NTP slave clocks /	
	Time zone server	off
	RS485 / telegram	off
Network	switching function	off
	DHCP	on
	DHCPv6	off
	Autoconf IPv6	off
	Link	auto
Alarm	Hostname	DTS4801
	Relay	all on, except 4 alarm inputs
	Mail	off
NW Services	SNMP traps	off
	SSH	on
	Telnet	on
SNMP	FTP	on
	Modus	off
	RO community	romobotime
SNMP Traps	RW community	rwmobotime
	Mode	off
	Trap community	trapmobotime

6 Operation

6.1 General

Operation occurs via a terminal menu or SNMP. SNMP operation is explained in Chapter 10 SNMP. Operation with the terminal menu takes place either via Telnet, SSH, or via a serial terminal. The serial terminal is particularly used for the first configuration. After a connection has been set up, the login screen is displayed:

```
DTS480x login:
```

To start the menu, *dts* must be logged in as user. The standard password is *dts*. (Changing the password → see Chapter “6.5.23 General Settings”).



Attention: The default password should be changed after receipt of the device!

Only one menu can be open at any time. The first menu started has priority. The menu is automatically closed after 15 min. without operation, and any possible connection via Telnet or SSH interrupted.

Backspace:

Backspace must be set to "delete" with the serial terminal:

Localecho:

Some terminals (serial or Telnet) do not display the characters entered. It is, therefore, necessary to switch on the "local echo" in the terminal.

6.1.1 Serial connection

38400 Bauds, 8 data bits, no parity, 1 stop bit.

Windows 7, 8, 10, 11: Putty

Linux: Minicom

Switch off Xon/Xoff and hardware handshake.

After establishing the serial connection, the menu can be initialized with ENTER.

When rebooting, the boot process will be displayed on the serial console.



Attention: The serial connection should always be disconnected before switching off the operating PC (exit terminal program or pull out the RS232).

6.1.2 Telnet

Windows 7, 8, 10, 11: e.g. with Putty
User: *dts*
Standard password: *dts*

Linux: Start console and enter "*telnet [IP-address]*"

6.1.3 SSH

Windows 7, 8, 10, 11: e.g. with Putty
User: *dts*
Standard password: *dts*

Linux: Start console and enter "*ssh dts@[IP-address]*"
Password: **dts**

6.1.4 Menu structure

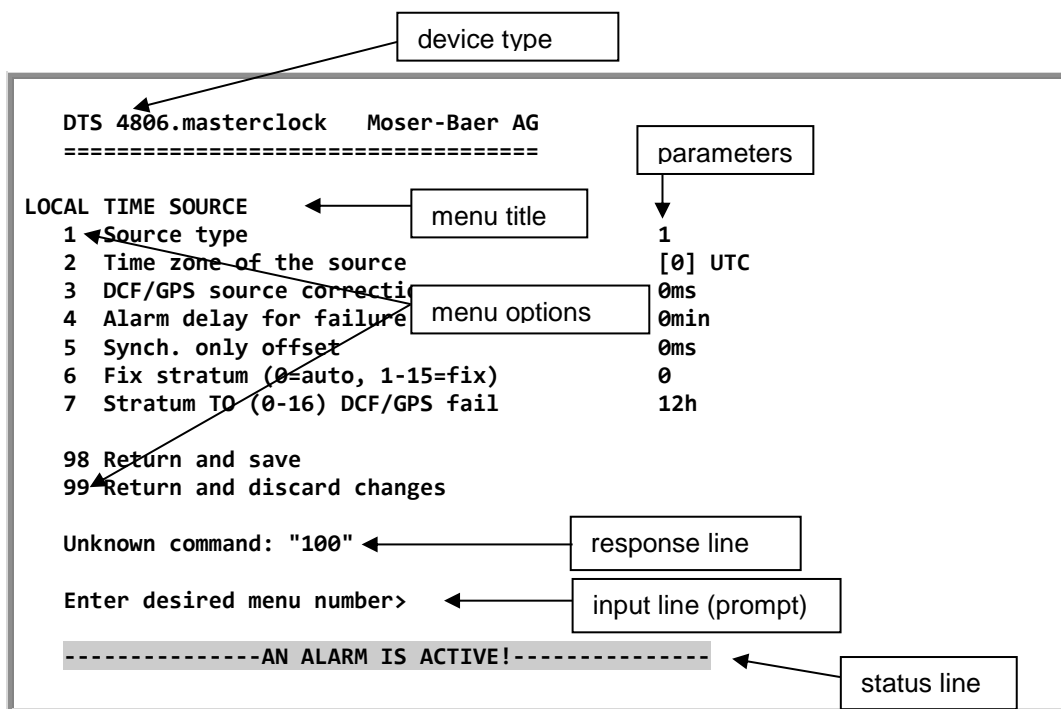

The current menu is always displayed in the **menu title**. The **menu options** show all the selectable menu functions. Provided the menu item is not a further menu, the set **parameters** are displayed. Error messages (e.g. invalid entries) or additional information to the selected menu items are displayed in the **response line**. The **input line** shows the current input values or options possible. The **status line** only appears, when information has to be displayed, e.g. "An alarm is active".

All entries must be completed with ENTER (Return) (e.g. also ESC).

The menu window can always be exited with *Ctrl-C* (incl. termination of the Telnet and SSH connection).

The desired menu can be selected with the relevant number.

The numbers 98 and 99 are always used identically:

- With 98, the settings entered are saved and the menu exited. Depending on the change, the DTS 480x or only partial functions are rebooted.
- With 99, all changes to the menu are reversed and the menu exited. In the menus where data cannot be saved (command 98), the menu is only exited with 99, but any changes are not saved.

The current menu is updated, without any further entry, with ENTER.

6.2 MOBA-NMS operation

For the configuration of DTS devices via GUI, MOBA-NMS (see chapter „3.7 MOBA-NMS - Network Management System“) can be used. All configuration possibilities are subordinated in different configuration pages (called „tabs“). These tabs are connected to the terminal menu and designated accordingly. Example: The terminal menu „Configuration → Alarms“ can be found in MOBA-NMS under the tab „Alarms“.

Configuration example of a DTS 4806.masterclock:

The screenshot displays the MOBA-NMS web interface for a DTS 4806 device. At the top, the device name 'DTS 4806' and status 'Status: OK' are shown. Below this, there are three main sections: 'List of active alarms' (showing three masked alarm inputs), 'Network' (showing IPv4 settings like IP address 172.16.30.206 and gateway 172.16.18.1), and 'State of the lines' (showing line 1 is in 'Run' state). Other sections include 'Time, time state' (showing UTC time Sep 9, 2020, 3:03:00 PM) and 'Local source' (showing actual measured offset of 0s 0us). A navigation bar at the bottom contains tabs for Overview, Outputs, Switching functions, Time handling, Alarms, Network, SNMP, and General, Services. A 'Refresh' button is located in the bottom right corner.

configuration pages
(tabs)

For further details on the general MOBA-NMS operation, check the integrated online help (menu „Help → Show help“).



Important: In order for the communication between MOBA-NMS and the DTS devices to work, SNMP must be activated! Set terminal menu „Configuration → SNMP → SNMP Mode“ to „on“. SNMP is active by default.

6.3 Main menu

```
DTS 4806.masterclock Moser-Baer AG
=====

MAIN SELECTION
1 Status
  (Actual alarms and history, timesource state, version)
2 Configuration
  (Configuration of the lines, timesources, alarms ...)
3 Maintenance
  (Update, backup ...)

99 Exit DTS menu

Enter desired menu number>
```

Menus:

- | | |
|---------------|---|
| Status | Display of various information regarding operation and environment
See Chapter "6.4 Status Menu" |
| Configuration | Configuration of the DTS 480x
See Chapter "6.5 Configuration Menu" |
| Maintenance | Software update, backup and restore
See Chapter "0 Maintenance Menu" |

6.4 Status menu

The status menu consists of 2 pages.

Status menu page 1:

```
DTS 4806.masterclock Moser-Baer AG
=====

CLOCK STATE                               Page 1
1 Alarm state
2 Alarm history
3 Time, time state
4 Local source
5 State of the lines
6 Info network config.
7 Internal state
8 Product information
9 Versions of the software

Press enter for next part, 99 to leave>
```

Path: 1 Status

The menu shows various information on the current operating status.

1. Requesting alarm status, display of all the DTS 480x active errors.
Display of the DTS 480x alarms (64) on 4 pages. The ALARM DETAIL menu pages can be scrolled through with ENTER. Active alarms are displayed with a *. The ALARM DETAIL menu page can be exited with 99. All DTS 480x active alarms are displayed, masking (e-mail, traps, relay) only occurs later.
2. Alarm history display.
Display of the DTS 480x alarm record, newest alarm first. The ALARM RECORD menu pages can be scrolled through with ENTER. The ALARM RECORD menu page can be exited with 99.
Max. length of error report: 240 messages.
3. Current time and status display. See Chapter "6.4.1 Time information and status "
4. Time source information display. See Chapter "6.4.2 Time source information "
5. Line information display (line time, status, line current)
6. Current network configuration display. With ENTER, a second page can be displayed with network information.
7. Internal system information display (internal status,..). This information is for support purposes only.
8. Product information's like serial number, firmware version etc.
9. All several software versions of the DTS 480x.

Status menu page 2:

```
DTS 4801.masterclock Moser-Baer AG
=====

CLOCK STATE                               Page 2
11 NTP peer state (ntpq -np)
12 NTP state (ntpq -c r1)

Press enter for next part, 99 to lave>
```

Path: 1 Status → [Enter]

Display of information with regard to the internal state of the NTP server.

6.4.1 Time information and status

```
DTS 4806.masterclock Moser-Baer AG
=====

TIME INFORMATION AND STATUS
Internal time of the DTS (local time)      08:49:54 01.11.18
Stratum of DTS                             3
Last corrected drift                       -0.ppm (31.463)
Time source                                Internal time
Offset to source                           0us
Jitter of the source                       2us
Stratum of the source                       2
Quality of the source                       100% (377)
CAN server

99 Return

Enter desired menu number>
```

Path: 1 Status → 3 Time, time state

- | | |
|-----------------------------|---|
| - Internal time of the DTS: | local time |
| - Stratum of DTS: | current stratum |
| - Last measured drift: | drift before the last quartz correction
in ppm (frequency of NTP) only for support |
| - Time source: | current time source |
| - Offset to source: | offset to source (source – system time) |
| - Jitter of the source: | current jitter |
| - Quality of the source: | quality of the source |
| - CAN server | current CAN server in CAN mode |

6.4.2 Time source information

```
DTS 4806.masterclock Moser-Baer AG
=====

LOCAL TIME SOURCE INFORMATION
Actual measured offset          0s 52500us
Last time received (DCF/serial) 06:03:00 01.12.20 (0)
Sec. counter                    7
Stratum of the source           3

99 Return

Enter desired menu number>
```

Path: 1 Status → 4 Local Source

- Currently measured offset: last measured offset
- Last time received DCF: last time received from DCF source
In "(" information about number of available satellites (only with GPS 4500).
With a DCF receiver this is a random value.
- Sec. counter DCF: the counter is incremented by 1 with each DCF pulse. For the minute marker, the counter is set to 0.
- Stratum of the source: stratum of the local time source can be defined with this value.

6.5 Configuration menu

```
DTS 4806.masterclock Moser-Baer AG
=====

CONFIGURATION
1 Outputs (line, pulse, ..)
2 Time handling (time source, ..)
3 Alarms
4 General
5 Network
6 Services (FTP, telnet, SSH)
7 SNMP
8 System voltage

99 Return

Enter desired menu number>
```

Path: 2 Configuration

Configuration of the DTS 480x via different sub-menus:

1. Configuration of the lines / outputs (MOBALine, impulse line, DCF active code line, DCF out, RS485 line, serial telegrams, NTP slave clock lines, switch functionality) see chapter "6.5.1 Lines"
2. Configuration of the time source, time keeping, etc.
See chapter "6.5.12 Time handling"
3. Alarm settings (alarm relais, e-mail, SNMP)
See chapter "6.5.18 Alarms"
4. General settings for the DTS 480x (language, time zone for alarms and display, password for menu...)
See chapter "6.5.23 General settings"
5. Network settings
See chapter "6.5.24 Network"
6. Services (switch network services such as FTP, Telnet, SSH on or off)
See chapter "6.5.25 Services (Network services FTP, Telnet, SSH....)"
7. SNMP configuration for GET/PUT.
See chapter "6.5.26 SNMP" (Traps are described with in menu '2. Configuration' → '3. Alarms' → '3. Traps'. See also chapter 6.5.22 SNMP Traps)
8. System voltage configuration (DTS 4806 only)
See chapter "System voltage"

6.5.1 Lines

Under lines, the settings for the following 5 functions can be made:

- MOBALine / Impulse line 1...6 / DCF active code line 1...6
 - ➔ see chapter 6.5.2 MOBALine
 - ➔ see chapter 6.5.3 Impulse line
 - ➔ see chapter 6.5.5 DCF active code line
 - ➔ see chapter 6.5.6 Combined DCF-Impulse

- DCF / Pulse output
 - ➔ see chapter 6.5.7 DCF / Pulse Output

- Ser. telegrams / RS485 Line
 - ➔ see chapter 6.5.8 Serial Telegrams
 - ➔ see chapter 6.5.9 RS485 Clock Line (RS 485 clock line only active with the DTS 4801)

- NTP slave clocks / time zone server
 - ➔ see chapter 6.5.10 NTP Slave clocks / Time Zone Server

- Switch functions
 - ➔ see chapter 6.5.11 Switch Functions

- IRIG / AFNOR (only DTS 4803)
 - ➔ see chapter 6.5.4 IRIG / AFNOR

6.5.2 MOBALine

MOBALine clock line with switch function for clock illumination, switch program and world time function. Display of line 1 to 6.

MOBALine configuration page 1:

```
DTS 4806.masterclock Moser-Baer AG
=====

MOBALine                               1      Page 1
1 Line type                             MBL
2 Line                                   on
3 Linemode (min)                         min
4 Linemode (sec)                         jump
5 Time zone                              [+1] Brussel
6 Max. current                           500mA
7 Min. current                           350mA

98 Return and save
99 Return and discard changes

Enter desired menu number or press enter for next part>
```

Path: 2 Configuration → 1 Outputs → 1 MOBALine / impulse line 1

1. Select line type: 0 = MOBALine, 1 = Impulse line, 2 = DCF active code line, 3 = DCF impulse line
2. Select line function: Line switched off, line switched on, let clocks run to 12:00.
3. Select MOBALine minute mode: Minute steps, 30 second steps or cont. (10 sec. steps)
4. Select MOBALine second mode: 0 = jump, 1 = continuous, 2 = continuous with stop, 3 = wobbling with stop
5. Select time zone (see chapter "6.5.29 Time zone selection")
6. Select maximum current (0-700mA) on the line. The line will be switched off for as long as the overcurrent is connected.
DTS 4802: The maximum current is divided between both lines, i.e. only the remainder can be set as the maximum amount.
7. Select minimum current (0-700mA) on the line. If the minimum current is underrun, the alarm 39 "Line x current too low" is activated (DTS 4806 only).

MOBALine configuration page 2:

```
DTS 4806.masterclock Moser-Baer AG
=====

MOBALine                               1      Page 2
8 Switching function                    off
9 World time function                   off
10 Configure time zone table (world time)

98 Return and save
99 Return and discard changes

Enter desired menu number or press enter for next part>
```

Path: 2 Configuration → 1 Outputs → 1 MOBALine / impulse line 1 → [Enter]

8. Switching function on or off
9. World time function on or off
10. Configure time zone table for world time

Important: Changes can only be undertaken when the clock line is switched off!



Time zone table for the world time function:

```
DTS 4806.masterclock Moser-Baer AG
=====

TIME ZONE - TABLE
Zone01: -1 Not configured      Zone02: -2 [+1] Brussel
Zone03: -1 Not configured      Zone04: -8 [+3] Kuwait
Zone05: -1 Not configured      Zone06: -19 [+9] Tokyo
Zone07: -1 Not configured      Zone08: -1 Not configured
Zone09: -1 Not configured      Zone10: -1 Not configured
Zone11: -1 Not configured      Zone12: -1 Not configured
Zone13: -1 Not configured      Zone14: -1 Not configured
Zone15: -1 Not configured      Zone16: -1 Not configured
Zone17: -1 Not configured      Zone18: -1 Not configured
Zone19: -1 Not configured      Zone20: -1 Not configured

Enter requested entry

Press enter for next part, 99 to leave>
```

Path: 2 Configuration → 1 Outputs → 1 MOBALine / impulse line 1 → 10 Configure Time zone table

Display of all time zone entries (20) of the world time function for MOBALine.

By entering a zone number, the particular entry can be changed.

Select time zone (see chapter “6.5.29 Time zone selection“)

Exit the page with 99. The changes are first saved on the overlying menu page or reset.

6.5.3 Impulse line

Impulse clock line with display of the line number page 1:

```
DTS 4806.masterclock Moser-Baer AG
=====

IMPULSE CLOCK LINE                               1      Page 1
1 Line type                                       Imp.
2 Line                                           on
3 Linemode                                       1sec
4 Line voltage                                   24V
5 Time zone                                     [+1] Brussel
6 Max. current                                  500mA
7 Min. current                                  0mA
8 Line time                                     07:39:39 02.11.09

98 Return and save
99 Return and discard changes

Enter desired menu number or press enter for next part>
```

Path: 2 Configuration → 1 Outputs → 1 MOBALine / impulse line 1

1. Select line type: 0 = MOBALine, 1 = Impulse line, 2 = DCF active code line, 3 = DCF impulse line
2. Select line function: Line switched off, line switched on
3. Select line mode: Minute steps, ½ minute steps, 1/5 minute steps, 1/8 minute steps, second steps
4. Select line voltage impulse line: 0=24V, 1=48V, 2=60V (DTS 4806 only)
5. Select time zone (see chapter “6.5.29 Time zone selection”)
6. Select maximum current (0-1000mA) on the line. The line will be switched off as long as the overcurrent is connected.
DTS 4802: The maximum current is divided between both lines, i.e. it can always only be the remainder at the most that can be set as maximum current.
7. Select minimum current (0-1000mA) on the line. If the minimum current is underrun, the alarm 39 current low is activated (DTS 4806 only).
8. Line time with the format: “hh:mm:ss YY.MM.DD”



Wichtig: Only for **DTS 4806 Extended:**

In case of powering the device with 110VAC and output voltage of the clock line is **48V** or **60V**, then please pay attention, that the output current has to be reduced, to prevent an overheating of the device in the catch up mode and therefore a switch off of the line because of too high temperature.

Therefore for the catch up mode with **110VAC** power supply and line voltage of **48V** or **60V** the total current of all lines should not exceed **3A** (50% of the maximum).

Impulse line configuration page 2:

```

DTS 4806.masterclock Moser-Baer AG
=====

IMPULSE CLOCK LINE                1      Page 2
9 Pulse time                       300ms
10 Pause time                      200ms
11 Catch up mode (0=12h, 1=24h, 2=week) 0

Enter desired menu number or press enter for next part>
    
```

Path: 2 Configuration → 1 Outputs → 1 MOBAline / impulse line 1 → [Enter]

- 9. Pulse time (200-30000ms, resolution approx. 50ms)
- 10. Pause time in catch-up (200-30000ms, resolution approx. 50ms)
- 11. Catch-up mode: 12 hrs, 24 hrs, 1 week



Important: Changes can only be undertaken when the clock line is switched off!

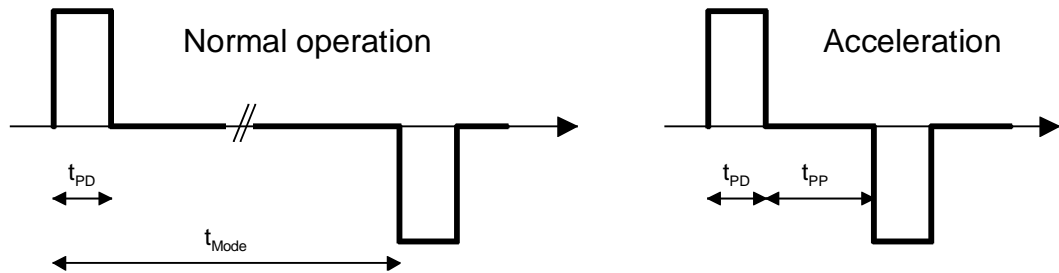

- t_{PD} : Pulse time
- t_{PP} : Pause time
- t_{Mode} : Impulse interval is determined by the line mode (e.g. min = 1 minute)

6.5.4 IRIG-B, AFNOR (DTS 4803 only)

IRIG-B / AFNOR Configuration:

```
DTS 4803.masterclock Moser-Baer AG
=====

IRIG / AFNOR OUTPUT 1
1 Mode AFNOR-A (NFS 87-500)
2 Time zone [+1] Brussel
3 Level (~Upp @ Ri=RI=50Ohm) 2000mV
4 Alarm signal level low (~Ueff) 200mV

98 Return and save
99 Return and discard changes

Enter desired menu number>
```

Path: 2 Configuration → 1 Outputs → [Enter] → 11 IRIG / AFNOR-Output

1. Select mode: see picture below
2. Select time zone (see chapter “6.5.29 Time zone selection“)
3. Configuration of the output voltage level:
The defined voltage corresponds to the expected output amplitude when power matching (impedance matching) with a load of 50 Ohms is fulfilled. The output voltage is not controlled, resp. it is not adjusted in case of a load change.
4. Configuration of the output voltage level supervision:
When the output voltage falls below the defined voltage level, an alarm is released.

```
DTS 4803.masterclock Moser-Baer AG
=====

SELECTION IRIG/AFNOR CODE
00: off
01: IRIG-B (B122)
02: IRIG-B 12h (B122)
03: IRIG-B DIEM (B122)
04: IRIG-B123
* 05: AFNOR-A (NFS 87-500)
06: AFNOR-C (NFS 87-500)
07: IRIG-B126 (127)

Enter requested audio code

ESC to leave>
```

6.5.5 DCF active code line

DCF active code line with display of the line number:

```
DTS 4806.masterclock Moser-Baer AG
=====

DCF ACTIVE CLOCK LINE                1
1 Line type                          DCF
2 Line                                off
3 Linemode                            0
4 Time zone                           [+1] Brussel
5 Max. current                         500mA
6 Min. current                         0mA

98 Return and save
99 Return and discard changes

Enter desired menu number>
```

Path: 2 Configuration → 1 Outputs → 1 MOBALine / impulse line 1

1. Select line type: 0 = MOBALine, 1 = Impulse line, 2 = DCF active code line, 3 = DCF impulse line
2. Select line function: Line switched off, line switched on
3. Select line mode: See the diagrams on the next page.
4. Select time zone (see chapter “6.5.29 Time zone selection“)
5. Select maximum current (0-1000mA) on the line. The line will be switched off as long as the overcurrent is connected and restarted only on the next minute.
DTS 4802: The maximum current is divided between both lines, i.e. it can always only be the remainder at the most, that can be set as maximum current.
6. Select minimum current (0-1000mA) on the line. If the minimum current is underrun, the alarm 39 current low is activated (DTS 4806 only).



Important: Changes can only be undertaken when the clock line is switched off!

The six different DCF active code modes:

Mode 1

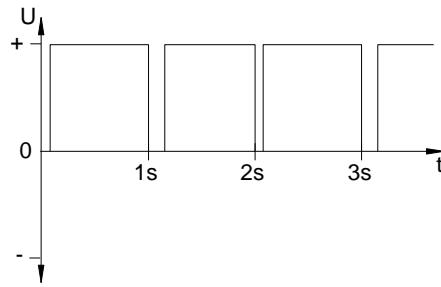

Mode 2

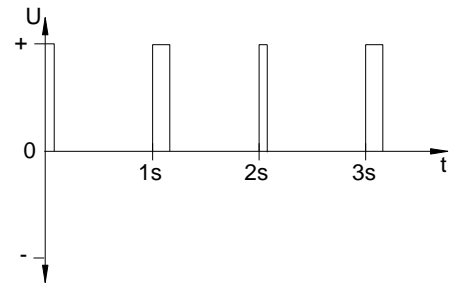

Mode 3

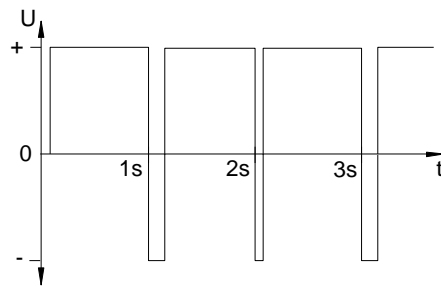

Mode 4

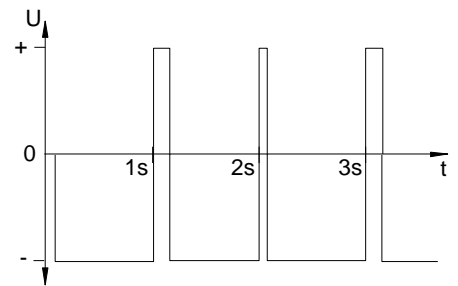

Mode 5:

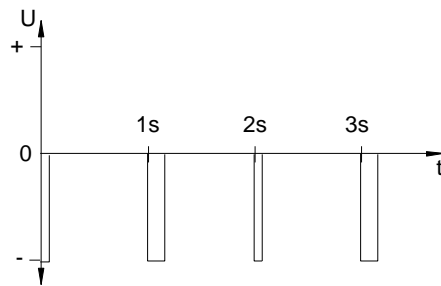

Mode 6

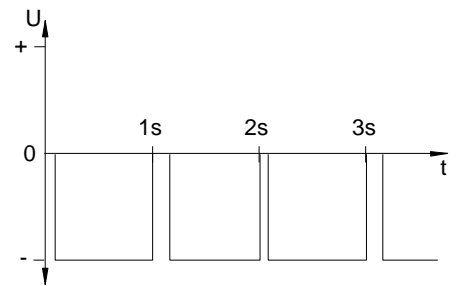

Mode 1/6, 2/5, 3/4 are equal. Their polarity only depends on how the line is connected to the DTS 480x.masterclock. The signal forms shows the voltage measured from terminal a to terminal b (refer to annex A).

6.5.6 Combined DCF-Impulse line

Combined DCF-Impulse line with display of the line number:

```
DTS 4806.masterclock Moser-Baer AG
=====

DCF-IMPULSE CLOCK LINE           6
1 Line type                       DCF-Imp
2 Line                             on
3 Linemode                         1min
4 Time zone                       [+1] Brussel
5 Max. current                     700mA
6 Min. current                     0mA
7 Line time                        12:00:00 23.08.22

98 Return and save
99 Return and discard changes

Enter desired menu number>
```

Path: 2 Configuration → 1 Outputs → 1 MOBALine / impulse line 1

1. Select line type: 0 = MOBALine, 1 = Impulse line, 2 = DCF active code line, 3 = DCF impulse line
2. Select line function: Line switched off, line switched on
3. Select line mode: Minute steps, ½ minute steps
4. Select time zone (see chapter “6.5.29 Time zone selection”)
5. Select maximum current (0-1000mA) on the line. The line will be switched off as long as the overcurrent is connected and restarted only on the next minute.
DTS 4802: The maximum current is divided between both lines, i.e. it can always only be the remainder at the most, that can be set as maximum current.
6. Select minimum current (0-1000mA) on the line. If the minimum current is underrun, the alarm 39 current low is activated (DTS 4806 only).
7. Line time with the format: “hh:mm:ss YY.MM.DD”



Important: Changes can only be undertaken when the clock line is switched off!

With the line type "DCF-Imp" it is possible to drive minute or ½ -minute impulse clocks and self-setting Active – DCF clocks on the same line. The following line modes are possible:

Line in normal operation: DCF time code output 24V, every minute / ½-minute the polarity is changing.

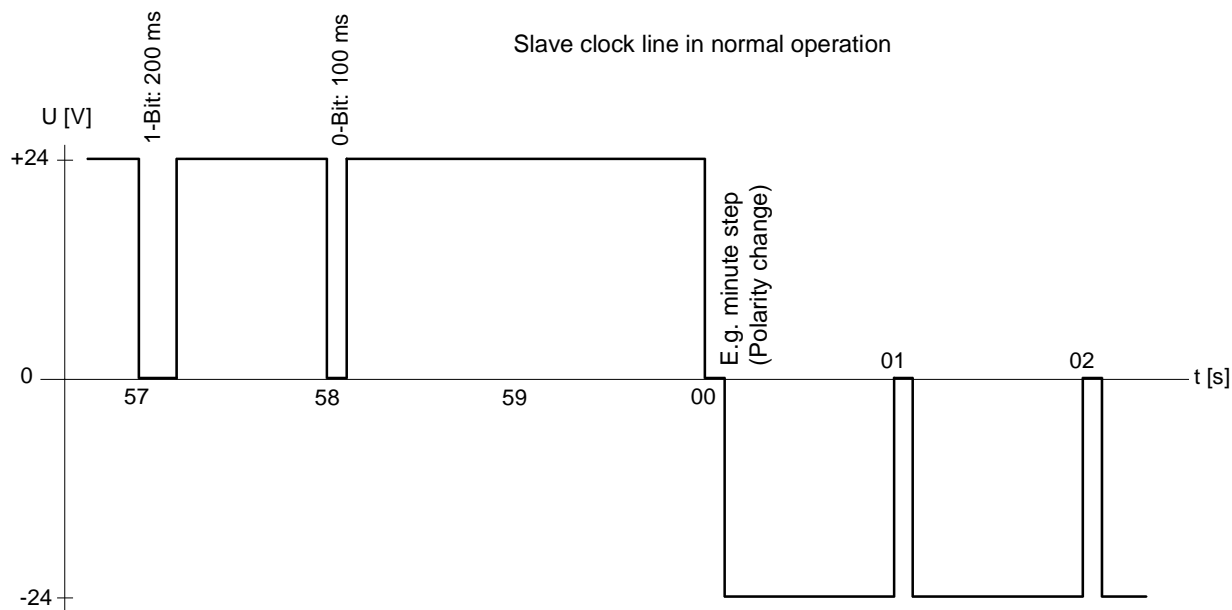

Line in catch-up mode: DCF time code output 24V, every sec. the polarity is changing except at the minute change.

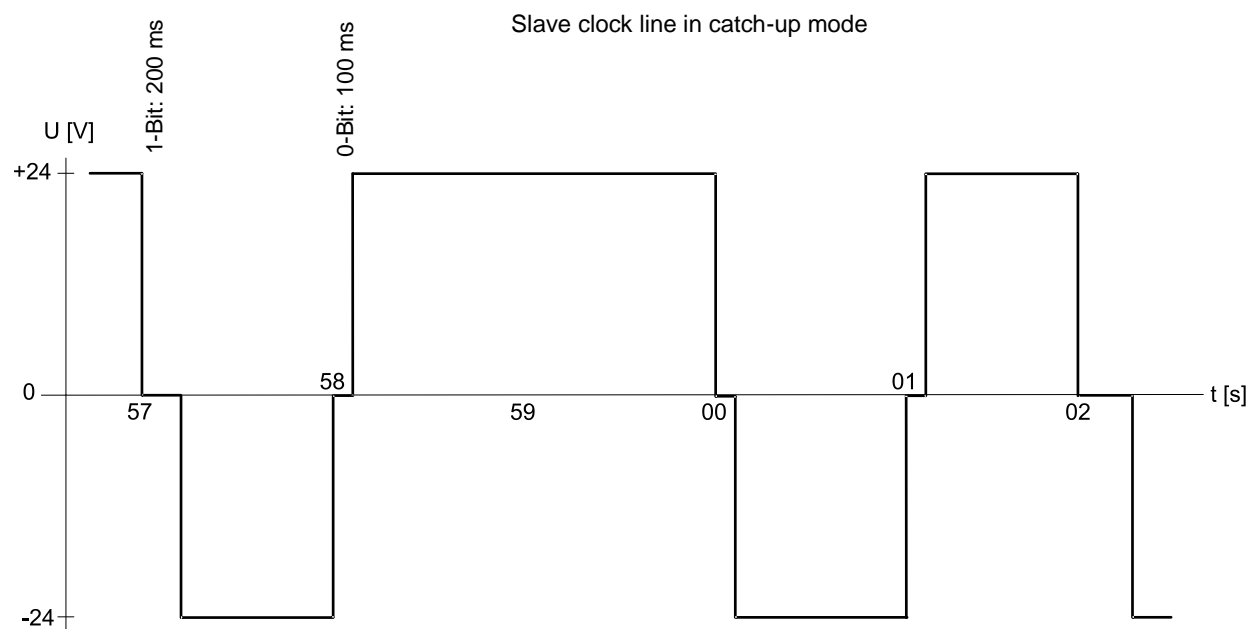

The following settings of the impulse line are fixed and cannot be modified:

Pulse duration:	1.8 or 1.9 s
Pulse pause:	0.2 or 0.1 s
Catch-up periodicity:	12 hours

6.5.7 DCF / Pulse output

```
DTS 4806.masterclock Moser-Baer AG
=====

DCF / PULSE OUTPUT
1 Mode (0=off, 1=DCF, 2=pulse)          1
2 Time zone                            [0] UTC
3 Pulse type (0=sec 1=min 2=hour 3=user) 0
4 Pulse length                          100ms
5 User defined pulse type                1sec
6 Correction of output                   0ms

98 Return and save
99 Return and discard changes

Enter desired menu number or press enter for next part>
```

Path: 2 Configuration → 1 Outputs → [Enter] → 7 DCF / pulse out

1. Select line function: Line switched off, line DCF output, line pulse output
2. Select time zone -> see chapter "6.5.29 Time zone selection"
3. Select pulse mode: every second, minute, hour or user-defined.
(Only active with the pulse output function)
4. Select pulse length in ms (20-500ms)
(Only active with the pulse output function)
5. User-defined pulse interval (1-3600 sec) only active with pulse type 3 (=user) (the value is also only then displayed). The pulse always occurs after a multiple of the pulse interval from the 0 second in the 0 minute, e.g.:
 - Pulse interval 960 sec. (16 min.)
 - ➔ Pulse occurs: 00:00:00, 00:16:00, 00:32:00, 00:48:00, 01:00:00, 01:16:00 ...
 - Pulse interval 25sec
 - ➔ Pulse occurs: 00:00:00, 00:00:25, 00:00:50, 00:01:15, 00:01:40, 00:02:05 ...
 - ... 00:59:35, 01:00:00, 01:00:25 ...
6. Output correction (-500ms...+500ms)

6.5.8 Serial telegrams

Serial telegram output via RS232 and RS485.

(RS485 and NMEA is only available with the DTS 4801)

```
DTS 4801.masterclock Moser-Baer AG
=====

SERIAL OUTPUT
1 Mode (0=off, 1=RS485, 2=telegr, 3=NMEA)  0
2 Time zone
3 Com Mode
4 Baudrate
5 Databit
6 Stopbit
7 Parity
8 Telegram file

98 Return and save
99 Return and discard changes

Enter desired menu number or press enter for next part>
```

Path: 2 Configuration → 1 Outputs → [Enter] → 8 Serial line / RS485 clock line

1. Select mode: 0 = Line switched off, 1 = RS485 line, 2 = serial telegrams, 3 =NMEA (→ RS485 line and NMEA only with DTS 4801).
NMEA only possible, when time source is set to “3 = serial”. The communication parameters are set automatically (read RS485, 4800, 8, keine, 1).
See chapter 6.5.14 Time source.
2. Select time zone (see chapter “6.5.29 Time zone selection“)
3. Com mode:
0 = off
1 = send
2 = read RS232
3 = read RS485
4 = send and read (read only from RS232)
5 = send and read (read only from RS485)
The modes 2 and 3 (read RS232 and read RS485) are not yet available.
4. Baudrate: 300, 600, 1200, 2400, 4800, 9600, 19200, 38400
5. Data bit: 7 or 8
6. Stop bit: 1 or 2
7. Parity:
8. Selecting telegram file changes to the menu “SELECTION OF FILE“

The description of the telegram function and the telegram file can be found in Appendix E Serial Telegrams.

Important: To set the parameters, the line type has to be selected first!

Notice: No flow control available.



Selection of the telegram file:

```
DTS 4801.masterclock Moser-Baer AG
=====

SELECTION OF FILE                               Page 1
00: MC482STD.TEL                               01: MC482UTC.TEL

Enter requested file number, 99 = no file

Press enter for next part, ESC to leave>
```

Path: 2 Configuration → 1 Outputs → [Enter] → 8 Serial line / RS485 clock line → 8 Telegram file

The copy procedure of telegram files is explained in chapter "8.11 Copying telegram or program files to DTS 480x.masterclock".

6.5.9 RS 485 Clock line

Monitored clock line for 31 slave clocks
(only available with the DTS 4801)

```
DTS 4801.masterclock Moser-Baer AG
=====

RS485 CLOCK LINE
1 Mode (0=off, 1=RS485, 2=teleg, 3=NMEA) 1
2 RS485 mode (0=off, 2=superv., 3=12h) 2
3 Time zone [ +1 ] Bruessel
4 Switching function (0=off, 1-64=channel) off
5 Slave clocks: configuration and info
6 Error list slave clocks

98 Return and save
99 Return and discard changes

Enter desired menu number>
```

Path: Configuration → 1 Outputs → 8 Serial line / RS485 clock line

1. Select mode: Line switched off, RS485 line, serial telegrams
2. RS-485 mode: Off, monitored, 12 o'clock position
3. Select time zone (see chapter "6.5.29 Time zone selection")
4. Switch function: 0=off, 1-64 = channel number of the switch functionality
5. Select and configure the slave clocks (menu RS 485 clock line)
6. Display error list (history) of the clock line (error list of the RS 485 slave clock line, see the following pages)

Important: To set the parameters, the line type has to be selected first!



The RS485 line communicates with the following communication parameters via the RS485 interface:

19200 bauds, 8 data bits, no parity, 1 stop bit, no flow control

The MOBA-RS485 PROTOCOL is used for the monitored clocks.

The broadcast function can be configured with the serial telegram MC482STD.TEL.
Communication parameters:

9600 bauds, 7 data bits, even parity, 1 stop bit, no flow control

Menu RS 485 Clock line

```
DTS 4801.masterclock Moser-Baer AG
=====

RS485 CLOCK LIST      State           Type           Light
[*] 01: Demo 1        running         SU190          OK
[*] 02: Demo 2        no connection   SU190          OK
[*] 03: Demo 3        running         SU190          OK
[ ] 04: Demo 4
[ ] 05:
[ ] 06:
[ ] 07:
[ ] 08:
[ ] 09:
[ ] 10:
[ ] 11:

Enter device number to configure

Press enter for next part, 99 to leave>
```

Path: Configuration → 1 Outputs → [Enter] → 8 Serial line / RS485 clock line → Slave clocks: configuration and info

Display of all the slave clocks (31) in the RS485 clock line on 3 pages. The different pages can be scrolled through by clicking ENTER. A monitored clock is displayed with an [*]. [] shows an unmonitored clock. In addition, the name, status, type and state of the light monitoring is displayed.

By entering the clock number, the page changes to that of the required slave clock:

```
DTS 4801.masterclock Moser-Baer AG
=====

RS485 DEVICE                               1
1 Mode (0=off, 1=supervision active)       1
2 Name                                     Demo 1
  State                                    running (0x000c 0x000e)
  Type                                     SU190
  Software                                 202290.0105
  State light                              OK

98 Return and save
99 Return and discard changes

Enter desired menu number>
```

Path: Configuration → 1 Outputs → [Enter] → 8 Serial line / RS485 clock line → Slave clocks: configuration and info → 1

1. Select clock function: Clock monitored on or off
2. Clock name for identifying the clock / clock location

Status of the clock: "operation", "no connection", "wrong time", "comm. error", "equipment error", "unknown",

(Comm. error: e.g. if 2 clocks have the same address)

In brackets behind the status: Info for support

Type of clock, e.g. SU 190, DMU 140, DMU 350, DC 57/100/180

Software and software version of the clock

Status of light monitoring

Alarm list of the RS485 slave clock line:

```
DTS 4801.masterclock Moser-Baer AG
=====

ALARM HISTORY RS485 LINE                               Page 1
01 Device01 Test1111 15:30:05 05.02.18 UTC no connection 08
02 Device01 Test1111 15:31:05 05.02.18 UTC running        00
03 Device01 Demo1    09:57:05 06.02.18 UTC no connection 08
04 Device02 Demo2    09:57:06 06.02.18 UTC no connection 08
05 Device01 Demo1    09:58:05 06.02.18 UTC running        00
06 Device01 Test1111 15:30:05 06.02.18 UTC no connection 08
07 Device03 Demo 3   16:11:12 07.02.18 UTC no connection 08
08 Device03 Demo 3   16:15:33 07.02.18 UTC running        00
09 Device04 Demo 4   10:13:09 08.02.18 UTC running        00

Press enter for next part, 99 to leave>
```

Path: Configuration → 1 Outputs → [Enter] → 8 Serial line / RS485 clock line → Error list slave clocks

Error number display (continuous), equipment number (clock number), name, date and time of the error in UTC, error name and error number.

The error list is deleted when the DTS 480x is restarted.

6.5.10 NTP slave clocks / Time zone server

NTP slave clock line for operating slave clocks on the LAN (Ethernet). With this clock line, a world time function can be realized.

```
DTS 4806.masterclock Moser-Baer AG
=====

NTP SLAVE CLOCKS AND TIME ZONE SERVER
1 Mode(0=off 1=NTP 2=NTP+TZ 3=TZ 4=TZ req.) 0
2 Multicastaddress 239.192.54.14
3 Multicastport 65534
4 Pollinterval for NTP 0
5 Packet time to live 1 hops
6 Repeat time to send TZ-tables 60sec
7 Delay time between packets 60sec
8 Configure time zone table

98 Return and save
99 Return and discard changes

Enter desired menu number or press enter for next part>
```

Path: 2 Configuration → 1 Outputs → [Enter] → 9 NTP slave clocks / time zone server

1. Mode of clock line: 0 = off, 1 = Send NTP multicast, 2 = Send NTP Multicast and time zone table, 3 = Send time zone table, 4 = Time zones on request, 5 (only for maintenance) = Send an empty time zone table and return to previous mode.
2. Multicast address for NTP and time zone server: **239.192.54.x**
Group address: x = 1..15 for MOBATIME devices, e.g. NCI, SEN 40.
3. Multicast port for time zone server (enter an arbitrary value, empty is not allowed ! Value e.g.: 65534). The port is also needed for requesting Time zone entries (mode 4).
4. Poll-interval for NTP Multicast in 2^{poll-values} in seconds (range: 1 – 16).
E.g. poll-value = 2 → interval: 2² = 4 sec., poll-value = 5 → interval: 2⁵ = 32 sec.
For redundant Multicast time servers see remark next page.
5. Packet time to Live (TTL) for NTP- and time-zone-Multicast-packets in hops.
(Number of Routers in a network to transfer the packets through; for simple network without routing, enter value "1", for 1 Router enter "2").
6. Repeat time to send time zone table: 10 – 86400 sec.
7. Delay time between the sending of the individual time zone entries (one entry per Multicast packet) of the table: 1 – 60 sec.
8. Configuration of individual time zone entries. Displays menu "TIME ZONE TABLE".



Important: Changes of multicast-address, pollinterval and TLL lead to a **restart** of the NTP server!

Important: For the operation of a **Multicast** communication (NTP and Time Zone Server) **the configuration of a gateway is required** (see chapter 6.5.24 Network). The gateway can be set manually or by using DHCP.
If no gateway is available, the own IP can be set as gateway.



Important: Redundant NTP Multicast time server:

If in the same network two NTP servers should send NTP with the same Multicast IP address (redundancy), then the first time server has to be configured with a small **pollinterval** (e.g. 2 → 4 sec.) and the second time server with a large pollinterval (min. 100 x larger, e.g. 9 → 512 seconds). As long as the first time server is sending NTP Multicast packets, the packets from second time server are ignored. This configuration is needed, to reach a defined situation for the end devices (the DTS 480x.masterclock with the more frequently NTP send rate gets higher priority for time reception).

Time zone table for the NTP slave clock line:

```

DTS 4806.masterclock  Moser-Baer AG
=====

TIME ZONE - TABLE
Zone01: 2 [+1] Brussel           Zone02: -2 [+1] Brussel
Zone03: 0 [0] UTC                Zone04: -5 [+2] Cairo
Zone05: 3 [+1] Athens           Zone06: -3 [+2] Athens
Zone07: -1 Not configured       Zone08: -1 Not configured
Zone09: -1 Not configured       Zone10: -1 Not configured
Zone11: -1 Not configured       Zone12: -1 Not configured
Zone13: -1 Not configured       Zone14: -1 Not configured
Zone15: -1 Not configured

Enter requested entry

Press enter for next part, 99 to leave>

```

Path: 2 Configuration → 1 Outputs → [Enter] → 9 NTP slave clocks / time zone server → 8 Configure time zone table

Display of all time zone entries (15) of time zone servers for NTP slave clock lines.

Choose a zone number to change selected zone.

Time zone selection (see chapter “6.5.29 Time zone selection“)

The page can be exited with 99. Changes are first stored or reset on the overlying menu page.

6.5.11 Switch function / Switch program

Switch functions for MOBALine (channel relay) and the RS485 clock line to switch the illumination of the slave clocks.

```
DTS 4806.masterclock Moser-Baer AG
=====

SWITCH FUNCTIONS
1 Time zone [ +1 ] Brussel
2 Program file Test.PRG
3 Switch function twilight
4 Control inputs
5 Actual channel conditions / manual control

98 Return and save
99 Return and discard changes

Enter desired menu number or press enter for next part>
```

Path: 2 Configuration → 1 Outputs → [Enter] → 10 Switching Functions

Time zone selection (see chapter "6.5.29 Time zone selection")

1. Selection of the program file changes to the menu "SELECTION OF FILE"
2. Switch function twilight changes to the menu "SWITCH FUNCTION TWILIGHT"
3. Control inputs changes to the menu "CONTROL INPUTS"
4. Actual channel conditions / manual control changes to the menu "CHANNEL STATE"

In chapter "11 Description of switch function" the construction and dependence of the switch function is described.

Selection of the switch program file:

```
SELECTION OF FILE Page 1
00: haustec.prg 01: haustec9.prg
02: haustech.prg 03: testprg1.prg

Enter requested file number, 99 = no file

Press enter for next part, ESC to leave>
```

Path: 2 Configuration → 1 Outputs → [Enter] → 10 Switching Functions → 2 Program file

Copying the program files is described in chapter "8.11 Copying telegram or program files to the DTS 480x.masterclock".

Enter **99** to remove the file selection.

Switching function twilight:

The switch function calculates sunrise and sunset on the basis of the position entered. The accuracy of the calculation is +/-5 min. within the limits 60° north 60° south.

The switch function can be linked with AND, OR, or exclusive to a channel.

```
DTS 4806.masterclock Moser-Baer AG
=====

SWITCHING FUNCTION TWILIGHT
1 Channel (1-64, 0=off) 10
2 Combination twilight function 0
3 Longitude in degrees, -=East -7.730°
4 Latitude in degrees, -=South 47.030°
5 On before sunrise 60min
6 Off after sunrise 60min
7 On before sunset 60min
8 Off after sunset 60min
  Actual state off
98 Return and save
99 Return and discard changes

Enter desired menu number or press enter for next part>
```

Path: 2 Configuration → 1 Outputs → [Enter] → 10 Switching Functions → 3 Switch function twilight

1. Channel: 0 = off, 1 - 64 = assigned channel.
2. Link Twilight:
 - 0 = Exclusive twilight function (the switch programs are hidden on this channel)
 - 1 = The twilight function is linked to the switch program OR
 - 2 = The twilight function is linked to the switch program AND
3. Position: longitude in degrees. East = negative. Example: -7.466° = E 7.466°
4. Position: latitude in degrees. South = negative. Example: 47.030° = N 47.030°
5. Switch on 0 – 600 min before sunrise (defines how many minutes before the calculated sunrise time it has to be switched on).
6. Switch off 0 – 600 min after sunrise (defines how many minutes after the calculated sunrise time it has to be switched off).
7. Switch on 0 – 600 min before sunset (defines how many minutes before the calculated sunset time it has to be switched on).
8. Switch off 0 – 600 min after sunset (defines how many minutes after the calculated sunset time it has to be switched off).
 - 1: With this value, the switch off time is delayed till the next sunrise → the illumination is switched on the whole night.

Actual state: shows if the switch function is on or off. The state change of the lines (MOBALine and RS485) can be delayed up to 1 min.

Control inputs:

Each of the 4 alarm inputs can be linked as control input or switch input to a channel with AND, OR, or exclusive.

```
DTS 4806.masterclock Moser-Baer AG
=====

CONTROL INPUTS
1 Channel input 1 (1-64, 0=off)           6
2 Combination input 1                     0
3 Channel input 2 (1-64, 0=off)           7
4 Combination input 2                     0
5 Channel input 3 (1-64, 0=off)           8
6 Combination input 3                     0
7 Channel input 4 (1-64, 0=off)           9
8 Combination input 4                     0

98 Return and save
99 Return and discard changes

Enter desired menu number>
```

Path: 2 Configuration → 1 Outputs → [Enter] → 10 Switching Functions → 4 Control Inputs

1. Channel Input 1: 0 = off, 1 – 64 = assigned channel.
2. Link Input 1: 0 = switch output exclusive (the switch programs are hidden on this channel)
1= The switch input is linked to the switch program OR
2 = The switch input is linked to the switch program AND
3. Channel Input 2: 0 = off, 1 – 64 = assigned channel.
4. Link Input 2: see no. 2
5. Channel Input 3: 0 = off, 1 – 64 = assigned channel.
6. Link Input 3: see no. 2
7. Channel Input 4: 0 = off, 1 – 64 = assigned channel.
8. Link Input 4: see no. 2

If an alarm input is used as switch input, it must be masked in all alarm masks.

In chapter “11 Description of switch function“ the set up and dependency of the switch functions are described.

Channel state:

```
DTS 4806.masterclock Moser-Baer AG
=====

CHANNEL STATE * = channel on, [ ]= channel locked
              ! = external input, s = twilight
01:  02:  03:  04:  05:  06:!*  07:!*  08:!*
09:!* 10:s 11:  12:  13:  14:  15:  16:
17:  18:  19:  20:  21:  22:  23:  24:
25:  26:  27:  28:  29:  30:  31:  32:
33:  34:  35:  36:  37:  38:  39:  40:
41:  42:  43:  44:  45:  46:  47:  48:
49:  50:  51:  52:  53:  54:  55:  56:
57:  58:  59:  60:  61:  62:  63:  64:

99 Return

Manual switching: Enter channel number

Enter desired menu number>
```

Path: 2 Configuration → 1 Outputs → [Enter] 10 → Switching Functions → 5 Actual channel conditions / manual control

Display of all 64 channels of the switch functions. A switched on channel is displayed with an [*]. [] shows a locked channel in a switched off state whereas [*] shows a switched on channel in a locked state.

An ! shows that the channel is linked to a control output.

An s shows that the channel is linked to the twilight calculation.

By entering a channel, the page can be changed to that of manual switching for that channel:



Important: After a restart or after changing the program file, it can take up to 2 min until the states displayed correspond to the effective states on the channel relay!

Manual switching:

```
DTS 4806.masterclock Moser-Baer AG
=====

MANUAL SWITCHING                               Channel: 1
1 Channel on
2 Channel off
3 Channel on and lock
4 Channel off and lock
5 Channel unlock

99 Return

Enter desired menu number>
```

Path: 2 Configuration → 1 Outputs → [Enter] → 10 Switching Functions → 5 Actual channel conditions / manual control → 1

1. Channel temporarily on: The channel is switched on immediately. The channel then takes over the state of the switch programs, switch function or switch inputs again. It can take up to 2 minutes to adopt.
2. Channel temporarily off: The channel is switched off immediately. The channel then takes over the state of the switch programs, switch function or switch inputs again. It can take up to 2 minutes to adopt.
3. Channel on and lock: The channel is switched on immediately and locked in this state.
4. Channel off and lock: The channel is switched off immediately and locked in this state.
5. Unlock channel: The channel takes over the state of the switch programs, switch function or switch inputs again. It can take up to 2 minutes to adopt.

6.5.12 Time handling

In the menu '2 Configuration → 2 Time handling', settings can be made for the following functions:

- General settings → See Chapter 6.5.13
- Configuration of the local time source → See Chapter 6.5.14
- NTP Server / NTP Sources → See Chapter 6.5.15
- CAN (MTC) → See Chapter 6.5.16
- Manual time set → See Chapter 6.5.17

6.5.13 General time configuration

```
DTS 4806.masterclock Moser-Baer AG
=====

GENERAL TIME CONFIGURATIONS
1 Stratum limit for synchalarm          5
2 Leap second mode                      0
3 Leap second date (UTC)                00:00:00 01.01.19

98 Return and save
99 Return and discard changes

Enter desired menu number or press enter for next part>
```

Path: 2 Configuration → 2 Time handling → 1 General time settings

1. Stratum limit for synchalarm:
Stratum limit (1-16) for generating the alarm „Failure time source Str“.
Default value: 5.
Explanation:
If the **stratum** of the DTS 480x is **higher** or **equal** than the value "**Stratum limits for synchalarm**", then after a fix delay of 1 min the alarm "**Failure time source Str**" occurs → **sync LED turns off !**
2. Mode leap second:
0 Off
1 Additional second is added to the time period set
Is set to 0=off after adding the leap second.
-1 A second is omitted at the time period set.
Is set to 0=off after adding the leap second.
2 Recognize leap second automatically. Only possible in the case of a source notifying the leap second!
3. Set period of time for the leap second in UTC with the format: "hh:mm:ss TT.MM.YY". The next usual time will be displayed as a proposal.

Description of leap second see chapter "9.8 Leap Second".

6.5.14 Time source

```
DTS 4806.masterclock Moser-Baer AG
=====

LOCAL TIME SOURCE
1 Source type 1
2 Time zone of the source [0] UTC
3 DCF/GPS source correction 0ms
4 Alarm delay for failure of the source 03min
5 Synch. only offset 0ms
6 Fix stratum (0=auto, 1-15=fix) 0
7 Stratum TO (0-16) DCF/GPS fail 1h

98 Return and save
99 Return and discard changes

Enter desired menu number>
```

Path: 2 Configuration → 2 Time handling → 2 Local time source setting

1. Source type: 0=none, 1=DCF, 2=internal, 3=serial ("serial" only in connection with NMEA, see chapter "6.5.8 Serial telegrams")
1. Time zone of the source: see chapter "6.5.29 Time zone selection"
2. DCF/GPS source correction: (-60000ms..+60000ms)
3. Alarm delay at failure of time source (minutes):
0 = off, 1 – 2'160min, default value = 0
Error: "Time source fail TO"
4. Synch. only offset: 0=off
100 - 5000ms= Limits as from which time is no longer accepted → Alarm "Syn only diff too big"
5. Fix stratum: 0=Stratum is calculated automatically on the basis of the time source
1 - 15=Stratum of the DTS 480x is set by means of the description in the table in chapter "9.4 Configuration and Use Cases"
6. Stratum TO (Timeout) (0-16) DCF/GPS fail:
Duration of stratum change 1 to 16 in the case of time loss (1-999h), e.g. 24 hrs → after DCF/GPS time source failed, stratum counts up from 1 to 16 within 24 hrs
Default value: 12h

For description of time source see chapter "9 Time administration"

6.5.15 NTP server

NTP can run as server or combined as server/client.

To run NTP as source (NTP as client), in the menu '2 Configuration' → '2 Time handling' → '3 NTP Server / NTP Sources' at least one server has to be set.

The exact behavior of NTP time sources is described in chapter "9.2 Time take-over, NTP".

Further 2 multicast or broadcast addresses can be configured:

```
DTS 4806.masterclock Moser-Baer AG
=====

NTP SERVER CONFIGURATION
1 Configuration timeserver address 1      10.241.0.65
2 Configuration timeserver address 2      ntp.test.org
3 Configuration timeserver address 3
4 Configuration timeserver address 4
5 Configuration multi-/broadcast address 1 10.240.255.255
6 Configuration multi-/broadcast address 2
7 NTP Authentication
   NTP slave clock line (info only)      239.192.54.14

99 Return

Enter desired menu number>
```

Path: 2 Configuration → 2 Time handling → 3 NTP server

- 1.-4. Summary about configured NTP – time sources. Select to configure and display changes to the menu "ENTRY TIMESOURCE"
- 5.-6. Summary about configured NTP – broadcast addresses. Select to configure and display changes to the menu "NTP MULTI- / BROADCAST-ENTRY"
7. NTP Authentication: Changes to the menu "NTP AUTHENTICATION"

Information about a multicast – address, configured for NTP slave clocks.

Configuration of the individual server/peer address:

```
DTS 4806.masterclock Moser-Baer AG
=====

ENTRY TIMESOURCE          1
1 Source                   ntp.test.org
2 Minpoll                  3
3 Maxpoll                  6
4 Server/Peer              server
5 Prefer                   off
6 Authentication key       off

98 Return and save
99 Return and discard changes

Enter desired menu number>
```

Path: 2 Configuration → 2 Time handling → 3 NTP server/NTP sources → 1..4 Configuration timeserver address

1. Insert time sources (IP-address or Name e.g. "ntp.metas.ch")
ENTER without entry of an address will delete value.
- 2.-3. **Minpoll** and **Maxpoll**: Inquiry interval $2^{\text{poll value}}$ in seconds.
0 = automatically
e.g. poll value=2 → interval 2: $2^2 = 4\text{sec.}$, poll value=5 → interval 5: $2^5 = 32\text{sec.}$
Range of poll values (exponent): 1 – 16
To get an exact synchronization it's better to limit Maxpoll to 6 (64 sec.).
4. Set type of inquiry: server or peer
5. Preferred source: on or off
If possible, one source should always be preferred (even if only one source is defined), except if DCF is active.
6. Authentication key: off, key number, autokey



Important: If a key number is entered, the entered key must also be added to the trusted keys.



Important: All changes lead to a **restart** of the NTP server!



Important: Maxpoll should not be selected under 4 (16 sec), as otherwise, internal trimmung may be inaccurate.
Maxpoll and Minpoll on automatic can lead to insufficient synchronization accuracy. The specified accuracies were measured with Minpoll = 3 and Maxpoll = 6.
The configuration server should be used as far as possible.

Configuration of the Multi- / Broadcast address:

```
DTS 4806.masterclock Moser-Baer AG
=====

NTP MULTI- / BROADCAST-ENTRY          1
1 Multi- or broadcast IP address      10.240.255.255
2 Interval                             4sec
3 TTL (only for multicast)            1hops
4 Authentication key                   off

98 Return and save
99 Return and discard changes

Enter desired menu number>
```

Path: 2 Configuration → 2 Time handling → 3 NTP server → 5 Configuration multi-/broadcast address 1

1. IP address of the destination network (multicast or broadcast).
ENTER without entering an address will delete the entry.
2. Interval for sending out the NTP information in seconds.
The interval is rounded after the entry to NTP standard, which only permits values of format 2^x : 1,2,4,8,16,32,64... maximum 65536 seconds.
3. TTL (time to live) in hops. Only required for multicast.
Number of routers over which the multicast packet should be transmitted: for simple networks without a router - enter 1, for 1 router - enter value 2.
4. Authentication key: off, key number, autokey



Important: All changes lead to a **restart** of the NTP server!

Configuration of the NTP authentication:

The NTP authentication is described in chapter “9.9 NTP authentication”.

```
DTS 4806.masterclock Moser-Baer AG
=====

NTP AUTHENTICATION
1 Import keys (from /ram)
2 Export keys (to /ram)
3 Trusted (active) keys           12 8 15
4 Request keys (ntpq)             8
5 Control keys (ntpd)             15
6 Autokey password                 Test1234
7 Autokey command
8 Access control for query        off

98 Return and save
99 Return and discard changes

Enter desired menu number>
```

Path: 2 Configuration → 2 Time handling → 3 NTP server → 7 NTP Authentication

1. Import keys (from/ram directory)
The file ntp.keys must first be copied into the directory /ram.



Attention: The file must be named exactly in this way and written entirely in small letters.

2. Export keys (to /ram directory)
The current ntp.keys file is written in the directory /ram.
3. Select the trusted keys separated by spaces
4. Select the request key
5. Select the control key
6. Set the auto key password
7. Execute for auto key commands:
 - gen_iff generate the IFF certificate
 - gen_gq generate the GQ certificate
 - gen_mv generate the MV certificate
 - gen_all generate all (IFF,GQ,MV) certificates
 - gen_client generate the client certificate
 - update_server update the server certificate
 - update_client update the client certificate
 - export_iff export the IFF server certificate to /ram. Parameter password of the client
 - export_gq export the GQ server certificate to /ram.
 - export_mv export the MV server certificate to /ram.
 - import_iff import the IFF server certificate from /ram.
 - import_gq import the GQ server certificate from /ram.
 - import_mv import the MV server certificate from /ram.
 - clear_ram delete the certificates in /ram
 - clear_keys delete the certificates in the NTP key directory

Example: *export_iff myPassword* exports the IFF client certificate to /ram.

8. Access control status request (ntp-query)
0 = all access allowed (default)

- 1 = access from local network allowed
- 2 = all access blocked

6.5.16 Communication Alarm Network (CAN) to MTC

```

DTS 4806.masterclock Moser-Baer AG
=====

CAN CONFIGURATION
1 Mode                                0

98 Return and save
99 Return and discard changes

Enter desired menu number>

```

Path: 2 Configuration → 2 Time handling → 4 CAN (MTC)

1. CAN –mode on or off

If CAN is switched on, all the time source entries are accepted according to the set values of the MTC CAN module U6.5. The time sources can no longer be changed if CAN is switched on on the DTS 480x.



Attention: If multicast is used, the local time source must be set to "local". Otherwise, it can be set to "off".

6.5.17 Manual time set

```

DTS 4806.masterclock Moser-Baer AG
=====

MANUAL TIME SET
1 Set time (UTC)
2 Adjust time

99 Return

Enter desired menu number>

```

Path: 2 Configuration → 2 Time handling → 5 Manual time adjustment

1. Set UTC time in the format "YY.MM.DD hh:mm:ss".
Time is set with ENTER!
2. Correct time in ms (- = backwards). Range: +/-10'000ms
Time is set with ENTER!

6.5.18 Alarms

Under alarms, settings can be undertaken for the following functions:

- Alarm relays → see chapter 6.5.19
- E-Mail → see chapter 6.5.21
- SNMP-Traps → see chapter 6.5.22

6.5.19 Alarm relays

```
DTS 4806.masterclock Moser-Baer AG
=====

ALARM CONFIGURATION 2
1 Alarmmask for relay

98 Return and save
99 Return and discard changes

Enter desired menu number>
```

Path: 2 Configuration → 3 Alarms → 1 Alarm relay

1. Alarm mask for relay (see chapter "6.5.20 Alarm mask")

6.5.20 Alarm mask

```
DTS 4806.masterclock Moser-Baer AG
=====

ALARMMASK Page 1
[ ]=error disabled, [*]=error enabled
[ ] Bit00: Alarm input 1 [ ] Bit01: Alarm input 2
[ ] Bit02: Alarm input 3 [ ] Bit03: Alarm input 4
[*] Bit04: Error bit4 [*] Bit05: DTS restart
[*] Bit06: Failure 5V [*] Bit07: Supply voltage low
[*] Bit08: Line 1 current high [*] Bit09: Wrong time zone line 1
[*] Bit10: Wrong time zone DCF ou [*] Bit11: Wrong time zone RS485
[*] Bit12: Error IRIG output [*] Bit13: Tele.-file invalid
[*] Bit14: Program file invalid [*] Bit15: Wrong time zone switch

Enter alarmnumber to alter mask

Press ENTER for next part, 99 to leave>
```

Path: 2 Configuration → 3 Alarms → 1 Alarm relay → 1 Alarm mask

Display of all the DTS 480x alarms (64) on 4 pages. Pages can be scrolled through with ENTER.

An alarm on the current page can be switched on or off by entering an error number. The page can be exited with 99. The modifications will be saved or restored one menu level higher in "ALARM CONFIGURATION". All Alarms with "Error bitxx" are not yet used.

A description of individual errors can be found in Appendix "C Alarm list".

The alarm masks for the various applications (E-Mail, SNMP, SNMP Traps, alarm relay) can differ.

The alarm masks only apply to the corresponding function, but not for the internal alarm recording (Menu '1. Status' → '1. Alarm state' and Menu '1. Status' → '2. Alarm history').

6.5.21 E-mail

E-mail alarm messages via SMTP.

E-mail configuration page 1:

```
DTS 4806.masterclock Moser-Baer AG
=====

MAIL CONFIGURATION                               Page 1
1 Mailmode                                       off
2 Alarmmask for mail                             f0 ff ff ff ff ff ff ff
3 Mailserver                                     10.240.0.3
4 Mailport (default 25)                          25
5 Destination mail address1                       mail1@test.org
6 Destination mail address2
7 Reply mail address                             mail2@test.org
8 From mail address                             mail3@test.org

98 Return and save
99 Return and discard changes

Enter desired menu number or press enter for next part>
```

Path: 2 Configuration → 3 Alarms → 2 E-Mail

1. E-mail function on or off.
2. Alarm mask for e-mail notifications (see chapter "6.5.20 Alarm mask")
Changes are stored or reset on the overlying menu page "MAIL CONFIGURATION".
3. IP address of the mail server e.g. 10.249.34.5
ENTER without entering an address will delete the entry.
4. Mail server port (often 25)
- 5.-6. Destination e-mail address
ENTER without entering an address will delete the entry.
7. Reply address (e.g. support, administrator...)
ENTER without entering an address will delete the entry.
8. Sender address (important for authentication through the mail server)
ENTER without entering an address will delete the entry.

Press ENTER to change to page 2.



Important: Configuration of a gateway is required for sending e-mails (see chapter "6.5.24 Network"). This can be set via DHCP or manually.

E-Mail configuration page 2:

```
DTS 4806.masterclock Moser-Baer AG
=====

MAIL CONFIGURATION                               Page 2
11 Authentication mode                            1
12 User name                                     username
13 Password                                     password

98 Return and save
99 Return and discard changes

Enter desired menu number or press enter for next part>
```

Path: 2 Configuration → 3 Alarms → 2 E-Mail → [Enter]

11. Authentication mode:

- 0=off (sender e-mail address used for authentication)
- 1=auto (tries CRAM-MD5, LOGIN- PLAIN in this sequence)
- 2=PLAIN
- 3=LOGIN
- 4=CRAM-MD5

12. User name (only for authentication mode 1-4)

13. Password (only for authentication mode 1-4)

Press ENTER to change to page 1.

Format of an error message via E-Mail:

```
Event <Alarm 21 set: NTP does not run>
Time <13:34:34 06.02.09>
Hostname <DTS480x (10.241.0.18)>
```

6.5.22 SNMP-Traps

For a description of SNMP functionality, see also chapter "10 SNMP".

```
DTS 4806.masterclock Moser-Baer AG
=====

SNMP-TRAP CONFIGURATION
1 Trap mode off
2 Alarmmask for trap f0 ff ff ff ff ff ff
3 Trap community string trapmobatime
4 Configuration of destination 1 10.240.10.44
5 Configuration of destination 2 10.240.0.85
6 Time periode for alive message 300sec

98 Return and save
99 Return and discard changes

Enter desired menu number>
```

Path: 2 Configuration → 3 Alarms → 3 Traps

1. Trap mode on or off
2. Alarm mask for SNMP trap messages (see chapter "6.5.20 Alarm mask")
Changes are first stored or reset on the overlying menu page "SNMP TRAP CONFIGURATION".
3. Trap community string (group membership for traps).
Standard: *trapmobatime*.
4. Configuration of the receiving system (trap sink) 1
5. Configuration of the receiving system (trap sink) 2
6. Time period for alive messages in seconds. 0 = no alive traps are sent
Range: 1-7'200sec



Important: General settings for SNMP can be found in menu '2. Configuration' → '7. SNMP'. See also chapter "6.5.26 SNMP").

Important: Configuration of a gateway is required for sending SNMP traps (see chapter 6.5.24 Network). This can be set via DHCP or manually.

Important: Each configuration change leads to a restart of the SNMP DTS Agent.

Important: SNMP has to be activated for sending traps.

Configuration of the receiving systems

```
DTS 4806.masterclock Moser-Baer AG
=====

SNMP-TRAP DESTINATION CONFIGURATION          1
1 Address trap destination                   10.240.10.44
2 Port trap destination (default 162)       162
3 SNMP version                               2

98 Return and save
99 Return and discard changes

Enter desired menu number>
```

Path: 2 Configuration → 3 Alarms → 3 Traps → 4 Configuration of destination 1

Address of the evaluation system e.g. 10.241.0.15.

ENTER without entering an address will delete the entry.

1. Port of the evaluation system (usually 162).
2. SNMP Version: 1=SNMP V1, 2=SNMP V2c



Important: Each configuration change leads to a restart of the SNMP DTS Agent.

6.5.23 General settings

```
DTS 4806.masterclock Moser-Baer AG
=====

GENERAL SETTINGS
1 Language                                     0
2 Timezone displayed times                    [+1] Brussel
3 Password (menu)                            dts

98 Return and save
99 Return and discard changes

Enter desired menu number>
```

Path: 2 Configuration → 4 General settings

1. Setting the display language
2. Setting the time zone for the display, and also all alarm logs, e-mail and SNMP. (See chapter “6.5.29 Time zone selection“)
3. Enter password for the menu (user *dts*) (max. 15 characters). A password must be configured.



Attention: The default password should be changed after receipt of the device!

6.5.24 Network

```
DTS 4806.masterclock Moser-Baer AG
=====

NETWORK GENERAL
1 IPV4 configuration
2 IPV6 configuration
3 Hostname (Devicename)           DTS480x
4 Domainname
5 Network interface               auto

98 Return and save
99 Return and discard changes

Enter desired menu number>
```

Path: 2 Configuration → 5 Network

1. Configuration of IPV4 parameters
2. Configuration of IPv6 parameters
3. Set hostname.



Attention: A host name must always be configured.

Host names and their format are described in the Internet standards RFC 952 and RFC 1123: Domains and host names may only contain letters (capitals or small letters) and numerals ("0-9"). In addition, the minus sign ("-") may also be used, as long as it is not at the end.

Everything else is not permitted!

4. Set domain e.g. test.org
5. Set network interface: Auto, 100/10Mbit, half-, full duplex.

View of the current network state in Menu: '1 Status' → '6 Info network config.'



Important: The menu is closed upon modifying the IP or the DHCP mode.



Important: DHCP on/off, each change of this setting will result in a **restart** of the NTP server!



Important: For the operation of a **Multicast** communication (NTP and Time Zone Server) **the configuration of a gateway is mandatory**. The gateway can be set manually or by using DHCP. If no gateway is available, the own IP address can be used.



Attention: Only one DNS server should be configured (IPv4 or IPv6).



Attention: Settings to the network must be agreed with the network administrator!

Network configuration IPv4:

```
DTS 4806.masterclock Moser-Baer AG
=====

NETWORK IPV4
1 DHCP off
2 IP address 10.99.3.2
3 Subnet mask 255.240.0.0
4 Gateway 10.96.2.1
5 DNS server 10.240.0.1

98 Return and save
99 Return and discard changes

Enter desired menu number>
```

Path: 2 Configuration → 5 Network → 1 IPV4 configuration

1. DHCP on or off, the following fields are not available in case of DHCP = on.
A DHCP **renew** can also be triggered via this point.



Important: DHCP on, if no DHCP server is available, leads to longer start-up time (<30 sec.) of the DTS 480x.

- 2.-5. Set IP address, subnet mask, gateway and DNS-Server. Format = 10.240.98.7

Network configuration IPv6:

```
DTS 4806.masterclock Moser-Baer AG
=====

NETWORK IPV6
1 Mode / Autoconf                on
2 DHCPv6                         on
3 IP address 1 / Prefix          fd03:4432:4646:3454::2000/64
4 Gateway 1                      fd03:4432:4646:3454::1
5 DNS server                     fd03:4432:4646:3454::1

98 Return and save
99 Return and discard changes

Enter desired menu number>
```

Path: 2 Configuration → 5 Network → 2 IPV6 configuration

Autoconf on or off

1. DHCPv6 on or off
2. IP address with prefix in IPv6 format
e.g. 2001:2345:6789::12:1:34/64
3. Gateway in IPv6 format
4. IPv6 DNS server

6.5.25 Services (network services FTP, telnet, SSH....)

Network services configuration:

```
DTS 4806.masterclock Moser-Baer AG
=====

NETWORK SERVICES
1 telnet                        on
2 ftp                          on
3 ssh, scp, sftp               on

98 Return and save
99 Return and discard changes

Enter desired menu number>
```

Path: 2 Configuration → 6 Services

- 1.-3. Switch the individual services off or on.



Attention: If the services are not used, FTP and Telnet should be switched off after receipt of the device.

6.5.26 SNMP

For a description of SNMP functionality, see also Chapter “10 SNMP”.

```
DTS 4806.masterclock Moser-Baer AG
=====

SNMP CONFIGURATION
1  SNMP mode                               on
2  Alarmmask for SNMP                      f0 ff ff ff ff ff ff ff
3  DTS location                            Communication center
4  Contact information                      test@test.org
5  SNMP V1/V2c security configuration
6  SNMP V3 security configuration

98 Return and save
99 Return and discard changes

Enter desired menu number>
```

Path: 2 Configuration → 7 SNMP

1. Mode Mode. 0=off, 1=on. SNMP information of MIB 2 is always available.

Important: To send out MIB-2 traps, the trap community and the destination address must at least be configured in menu '2. Configuration' → '3. Alarms' → '3. Traps' at least the trap community and the receiver must be configured. See also chapter “6.5.22 SNMP Traps”).

2. Alarm mask for SNMP status (see chapter "6.5.20 Alarm mask"). The modifications will be saved or restored one menu level higher in “SNMP CONFIGURATION”.
3. Location information which is displayed in SNMP management tool.
4. Contact information which is displayed in SNMP management tool.
5. Configuration of SNMP V1 / V2 c (specific settings). See chapter “6.5.27 SNMP V1 / V2c”
6. Configuration of SNMP V3 (specific settings). See chapter “6.5.28 SNMP V3”

Important: Each configuration change leads to a restart of the SNMP DTS Agent.



6.5.27 SNMP V1 / V2c

```
DTS 4806.masterclock Moser-Baer AG
=====

SNMP V1/V2c CONFIGURATION
1 Readonly community string          romobotime
2 Read/write community string        rwmobotime

98 Return and save
99 Return and discard changes

Enter desired menu number>
```

Path: 2 Configuration → 7 SNMP → 5 SNMP V1/V2

1. Community string for **read only** (Group membership for GET).
Standard: *romobotime*.
2. Community string for **read/write** (Group membership for GET/PUT).
Standard: *rwmobotime*.



Important: Each configuration change leads to a restart of the SNMP DTS Agent.

6.5.28 SNMP V3

```
DTS 4806.masterclock Moser-Baer AG
=====

SNMP V3 CONFIGURATION
1 User 1 configuration (dtsUser1)
2 User 2 configuration (dtsUser2)
3 Access 1 configuration (viewDTS1)
4 Access 2 configuration (viewDTS2)

99 Return

Enter desired menu number>
```

Path: 2 Configuration → 7 SNMP → 6 SNMP V3

1. - 2. Configuration of user-defined SNMP accounts dtsUser1 and dtsUser2

3. - 4. Configuration of user-defined SNMP access rights viewDTS1 and viewDTS2

Important: Each configuration change leads to a restart of the SNMP DTS Agent.

User configuration SNMP V3:

```
DTS 4806.masterclock Moser-Baer AG
=====

SNMP V3 USER CONFIGURATION
1 Password for authent. and privacy          dtsUser1
2 Min security level                         mobatime
3 Read access (read view)                   priv
4 Write access (write view)                 viewDTSInfo_
                                           _none_

98 Return and save
99 Return and discard changes

Enter desired menu number>
```

Path: 2 Configuration → 7 SNMP → 6 SNMP V3 Configuration menu → 3 User 1 configuration (DTSUser1)

1. Password for authentication (MD5) and privacy (DES). 8 – 40 characters
2. Minimal security level: 0=noauth (no authentication)
1=auth (only authentication)
2=priv (authentication and privacy)
3. SNMP read access: 0=none (no access)
1=all (full access)
2=DTS info (only DTS specific information)
3=user defined 1 (viewDTS1)
4=user defined 2 (viewDTS2)
4. SNMP write access: 0=none (no access)
1=all (full access)
2=DTS info (only DTS specific information)
3=user defined 1 (viewDTS1)
4=user defined 2 (viewDTS2)



Important: Each configuration change leads to a restart of the SNMP DTS Agent.

Access configuration SNMP V3:

```
DTS 4806.masterclock Moser-Baer AG
=====

SNMP V3 ACCESS CONFIGURATION          viewDTS1
1 Include OID 1                       .1.3.6.1.4.1.8072
2 Include OID 2                       .1.3.6.1.4.1.2021
3 Include OID 3                       .1.3.6.1.4.1.13842.4
4 Exclude OID 1                       .2
5 Exclude OID 2                       .2
6 Exclude OID 3                       .2

98 Return and save
99 Return and discard changes

Enter desired menu number>
```

Path: 2 Configuration → 7 SNMP → 6 SNMP V3 → 3 Access

- 1. - 3. Include View path, form: `.1.3.6.1.4.1.13842.4` (e.g. DTS) or `.iso` (complete SNMP ISO path).
- 4. - 6. Exclude View path: analogue include.



Important: Each configuration change leads to a restart of the SNMP DTS Agent.

6.5.29 Time zone selection

```
DTS 4806.masterclock Moser-Baer AG
=====

SELECTION TIME ZONE                               Page 1
* 00: [0] UTC                                     01: [0] London
  02: [+1] Brussel                                03: [+2] Athens
  04: [+2] Bucharest                               05: [+2] Cairo
  06: [+2] Amman                                   07: [0] UTC
  08: [+3] Kuwait                                  09: [-1] Cape Verde
  10: [0] UTC                                       11: [+4] Abu Dhabi
  12: [+4.5] Kabul                                  13: [-8] Pitcairn Is.
  14: [+5] Tashkent                                15: [+5.5] Mumbai
  16: [+6] Astana                                   17: [+7] Bangkok
  18: [+8] Singapore                               19: [+9] Tokyo

Enter requested time zone

Press enter for next part, ESC to leave>
```

Path: 2 Configuration → 2 Time handling → 2 Local time source setting → 2 Time zone of the source

Display of all the DTS 480x time zones (100) over several pages. The pages can be scrolled through with ENTER.

A time zone can be selected on the actual page by entering a time zone number.

Only one time zone is selected at any time.

Press ESC to leave the page. The modifications will be saved or restored one menu level higher.

6.5.30 System voltage (DTS 4806)

System voltage is only relevant for the device DTS 4806.

```
DTS 4806.masterclock Moser-Baer AG
=====

SYSTEM VOLTAGE
1 System voltage           60V
2 Configuration mode      auto
3 Supply type             internal (AC)

98 Return and save
99 Return and discard changes

Enter desired menu number>
```

Path: 2 Configuration → 8 System voltage

1. System voltage: 0=24V, 1=48V, 2=60V
2. Configuration mode: 0=auto, 1=fixed

In the „auto“ configuration mode, the system voltage is configured automatically during the boot sequence.

3. Supply type: internal (AC power supply) or external (DC)
This point is for information only, read-only access



Important: If the „auto“ configuration mode is set, the device must be rebooted upon any change in the power supply!



Important: If the device is operated with redundant power supply (AC mains supply with additional backup DC supply), the device must be booted with DC supply. After the booting procedure, the additional mains supply can be connected.

6.6 Maintenance menu

```
DTS 4806.masterclock  Moser-Baer AG
=====

MAINTENANCE
1 Update software (FTP)
2 Update software (USB)
3 Backup configuration and log to USB
4 Backup configuration local (on device)
5 Restore local backup configuration
6 Restore default MOBA configuration
7 Restart device
8 Copy telegram- and program-files

99 Return

Enter desired menu number>
```

Path: 3 Maintenance

1. Initiating a software update (files must have been copied by FTP into the directory */ram* of the DTS 480x before). → See chapter "7 Updates". The command always leads to a restart of the DTS 480x (even if no files were copied for update)

 **Important:** Possibly save configuration first.

2. Initiate a software update (files must first be put on to a USB stick in the DTS 480x). → See chapter "7 Updates". The command always leads to a restart of the DTS 480x.masterclock (even if no files were copied for update)

 **Important:** Possibly save configuration first.

3. Save the entire configuration (incl. program and telegram files) and the log files on a USB stick . Also generates a diagnosis file (*dts480xsystem_XXXXXXXXXX.log*) in the directory */ram* which is also copied on to the USB stick or which can be downloaded per FTP (only for support).
4. Backup the entire configuration locally (to the device)
5. Restore the entire configuration from a backup stored locally (on the device). After the restore the DTS 480x is automatically restarted.
6. Restore the entire configuration to factory settings. After the restore the DTS 480x is automatically restarted.
7. Restart DTS 480x.masterclock.
8. Copy telegram or program files on to the DTS 480x.masterclock. → See chapter "8.11 Copying telegram or program files on to the DTS 480x.masterclock".

See also chapter "7 Updates".

7 Power supply and voltage monitoring

7.1 Connection methods

The DTS 480x can be powered in two different ways: either by mains voltage (230 VAC +/- 10%, 50/60 Hz) or via an external direct current voltage source (24 VDC for DTS 4801 and DTS 4802, 24-72 VDC for DTS 4806). Compare to annex A.

7.2 Power reserve battery (DTS 4806)

The DTS 4806 also offers the possibility to connect a lead-acid battery for power reserve (24VDC). This power reserve preserves all functions of the DTS 4806 Standard during a power outage. The battery is monitored by the DTS 4806, i.e. it gets recharged and is protected against deep discharge.



Attention: A connected battery is only switched on when the power supply is switched back on. This goes for charged batteries as well.

7.3 System voltage (DTS 4806)

The DTS 4806 is equipped with a system voltage monitor. In order for the DTS 4806 to be able to monitor the voltage, the system voltage to be monitored must be configured manually or detected automatically. Available system voltages are 24V, 48V and 60V.

7.3.1 System voltage configuration

DTS 4806 Standard:

The system voltage of the DTS 4806 Standard is always 24V, regardless of the system voltage mode (automatic, fixed).

DTS 4806 Extended:

If the system voltage is to be configured manually, the device is to be operated in the fixed system voltage mode (compare chapter 6.5.30 System voltage (DTS 4806)). In the fixed system voltage mode, the system voltage of a DTS 4806 Extended can be set to 24V, 48V or 60V.

If the system voltage is to be configured automatically, the device must be operated in the automatic system voltage mode (compare chapter 6.5.30 System voltage (DTS 4806)). In the automatic system voltage mode, the incoming DC voltage is measured during the boot sequence of the DTS 4806 Extended and the device is set to a system voltage according to the table below. If the DTS 4806 Extended is powered solely with AC, the system voltage is 60V.



Important: If the device is operated with redundant power supply (AC mains supply with additional backup DC supply), the device must be booted with DC supply. After the booting procedure, the additional mains supply can be connected.

Detection of the system voltage of the DTS 4806 Extended in the automatic system voltage mode:

Detected system voltage	Minimum DC voltage	Maximum DC voltage
24 V	22 V	31 V
48 V	35 V	53 V
60 V	59 V	70 V

7.3.2 System voltage monitoring (DTS 4806)

If the undervoltage or overvoltage of the voltage range is underrun resp. overrun, the lines are stopped and the device signals an alarm. At a voltage of less than 19V, the active power reserve battery is disconnected to protect it from deep discharge (compare chapter 7.2). The table below shows the monitored undervoltage and overvoltage limits in the respective system voltage ranges.



Table with under- and overvoltage limits (alarm hysteresis = 2 V):

System voltage	Undervoltage ± 2V	Overvoltage ± 2V
24 V	20 V	32 V
48 V	38 V	60 V
60 V	50 V	72 V

8 Updates

8.1 Image and file names

Image and file names differ between device versions:

Device	DTS 4801 V1 DTS 4802 V1	DTS 4801 V2 DTS 4802 V2 DTS 4803 DTS 4806
 		
Name Image		
Device application	dtsapp.img	dts480xapp.ubifs
RootFS image	rootfs.img	dts480xrootfs.ubifs
Boot image	u-boot.bin	dts480xu-boot.imx
zImage	ulImage26	dts480xzImage
Configuration	dtscfg.img	dts480xcfg.ubifs
Devicetree file	n/a	dts480xdevicetree.dtb
Checksum file	dtscheck.md5	dts480xcheck.md5
Name File		
Application	dts4801	dtsapp
Menu	dts4801menu	dtsmenu
NTP	ntpd	ntpd
Driver module	dts4801mod.ko	dtsdriver.ko
Configuration	dts4801.conf	dtsdevice.conf

8.2 Updating images with MOBA-NMS

Steps for updating images using MOBA-NMS:

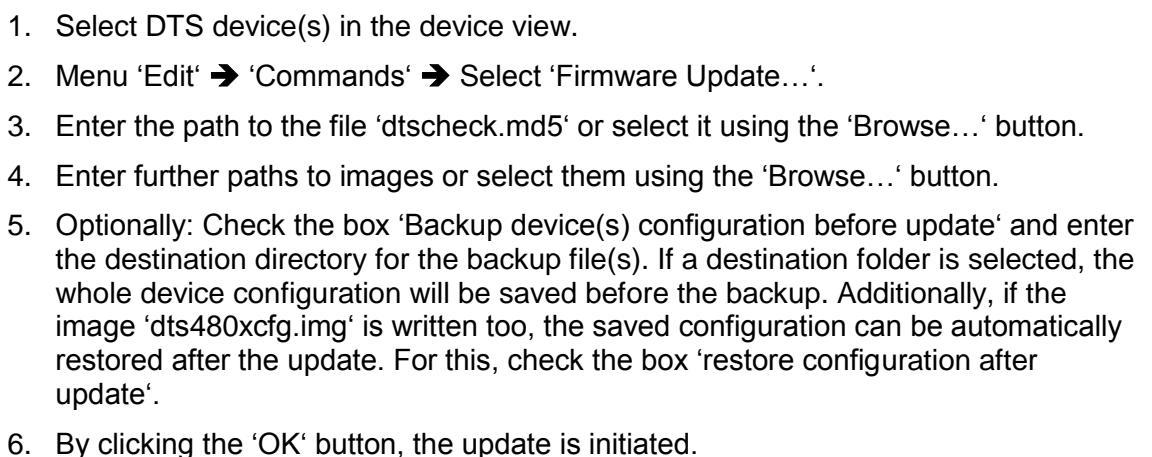
1. Select DTS device(s) in the device view.
2. Menu 'Edit' → 'Commands' → Select 'Firmware Update...'.

3. Enter the path to the file 'dtscheck.md5' or select it using the 'Browse...' button.
4. Enter further paths to images or select them using the 'Browse...' button.
5. Optionally: Check the box 'Backup device(s) configuration before update' and enter the destination directory for the backup file(s). If a destination folder is selected, the whole device configuration will be saved before the backup. Additionally, if the image 'dts480xcfg.img' is written too, the saved configuration can be automatically restored after the update. For this, check the box 'restore configuration after update'.
6. By clicking the 'OK' button, the update is initiated.

Attention: The update procedure (item 6) can take some time (<5 min.) and may not be interrupted under any circumstances. In case of an interruption, the software on the DTS 480x is destroyed and it can only be repaired in the factory.



8.3 Updating images via FTP

The images according to the table in chapter 8.1 can be updated using FTP. Additionally the file `dts480xcheck.md5` must exist.

→ **all image names are case-sensitive.**

Steps for updating images via FTP:

1. Connect a FTP client software (**binary**) to the DTS 480x.masterclock e.g. with Windows file Explorer enter: `ftp://dts@[IP address]` (as user dts). See also chapter "8.7 FTP-Connection"
2. If an update of the image **dts480xcfg.ubifs** is made, the configuration of the DTS 480x and the program and telegram files are overwritten. In order to store the configuration, the file `dtsdevice.conf` from the directory `/etc` and any possible program and telegram files must be saved from the directory `/var/local/dts`. After the update, the file can again be written on the DTS 480x in accordance with chapter "8.4 Updating applications or configurations via FTP". **Impulse lines** should be stopped before the update with `dts480x.ubifs` and separated from the DTS 480x (after the update, the line starts with `MOBALine`).
3. Change to the directory `/ram`.
4. Copy the image into the directory `/ram`.
5. Close FTP connection.
6. The update procedure can be started on DTS 480x by selecting the menu '3. Maintenance' → '1. Update software (FTP)' and press ENTER. The message "Update in progress" appears and at the same time, "Please wait!>" is shown in the command line. All images are copied. The DTS 480x is automatically restarted on completion of the update. The Telnet or SSH session has to be restarted.



Attention: The update procedure (point 6) may take longer time depending on the type and number of images (<5 min) and must not be interrupted under any circumstances. If interrupted, the software on the DTS 480x will be destroyed and it has to be returned to the manufacturer for repairing.

Starting up after an update can also take some minutes (<10 min), or it can result in an additional restart, as the file systems have to be checked first.

To eliminate any mistakes during update procedure, the versions should be verified after the update.

8.4 Updating applications or configurations via FTP

To update individual files as listed in the table in chapter 8.1. on the DTS 480x, the following steps are carried out:

→ **All file names are case-sensitive.**

1. Connect a FTP client software (**binary**) to the DTS 480x e.g. with Windows file Explorer enter: `ftp://dts@[IP address]` (as user dts). See also chapter 8.7 FTP-Connection
2. Change to the directory `/ram`.
3. Copy all the files to be updated into the directory `/ram`.
4. Close FTP-Connection.
5. The update procedure can be started on DTS 480x by selecting the menu '3. Maintenance' → '1. Update software (FTP)' and press ENTER.

The message "Update in progress" appears and at the same time, "Please wait!>" is shown in the command line. All images are copied. The DTS 480x is automatically restarted on completion of the update.
The Telnet or SSH session has to be restarted.



Attention: The update procedure (point 5) may take longer time depending on the type and number of images (<5 min) and must not be interrupted under any circumstances. If interrupted, the software on the DTS 480x will be destroyed and it has to be returned to the manufacturer for repairing.

To eliminate any mistakes during update procedure, the versions should be verified after the update.

8.5 Updating images via USB

The images as shown in the table in chapter 8.1 can be updated via USB. Additionally the file `dts480xcheck.md5` must exist.

➔ **all file names are case-sensitive.**

Steps for updating images:

1. Copy images to the USB stick
2. Plug the stick in the DTS 480x.masterclock

Important: USB stick plugged in:

Do **NOT** press the red button, after inserting the USB stick.
Start update, before main display appears again (timeout).

3. If an update of the `dts480xcfg.ubifs` image is made, the configuration of the DTS 480x and the program and telegram files are overwritten. In order to store the configuration, the file `dtsdevice.conf` from the directory `/etc` and any possible program and telegram files must be saved from the directory `/var/local/dts`. After the update, the file can again be written on the DTS 480x in accordance with chapter "8.4 Updating applications or configurations via FTP". **Impulse lines** should be stopped before the update with `dtscfg.img` and separated from the DTS 480x (after the update, the line starts with `MOBALine`).
4. The update procedure can be started on DTS 480x by selecting the menu '3. Maintenance' ➔ '2. Update software (USB)' and press ENTER. The message "Update in progress" appears and at the same time, "Please wait!>" is shown in the command line. All images are copied. The DTS 480x is automatically restarted on completion of the update. The Telnet or SSH session has to be restarted.
5. As soon as the DTS 480x is restarted, remove the USB stick.

Attention: The update procedure (point 4) may take longer time depending on the type and number of images (<5 min) and must not be interrupted under any circumstances. If interrupted, the software on the DTS 480x will be destroyed and the DTS 480x has to be returned to the manufacturer for repairing.



Starting up after an update can also take some minutes (<10 min), or it can result in an additional restart, as the file systems have to be checked first .

To eliminate any mistakes during update procedure, the versions should be verified after the update.

8.6 Updating applications or configurations via USB

To update individual files as shown in the table in chapter 8.1 on the DTS 480x, the following steps are carried out:

➔ **all file names are case-sensitive.**

1. Copy applications (or configuration) to the USB stick
2. Plug the stick in the DTS 480x



Important: USB stick plugged in:

Do **NOT** press the red button, after inserting the USB stick.
Start update, before main display appears again (timeout).

3. The update procedure can be started on DTS 480x by selecting the menu '3. Maintenance' ➔ '2. Update software (USB)' and press ENTER.
The message "Update in progress" appears and at the same time, "Please wait!>" is shown in the command line. All applications are copied. The DTS 480x is automatically restarted on completion of the update.
The Telnet or SSH session has to be restarted.
4. As soon as the DTS 480x is restarted, remove the USB stick.



Attention: The update procedure (point 0) may take longer time depending on the type and number of images (<5 min) and must not be interrupted under any circumstances. If interrupted, the software on the DTS 480x will be destroyed and it has to be returned to the manufacturer for repair.

To eliminate any mistakes during the update procedure, the versions should be verified after the update.



Important: USB stick recognition:

After removing the USB stick, wait approx. 1 min. before re-inserting the it again. Otherwise it can be, that the USB stick is not recognized.

8.7 FTP connection

Establish anonymous connection:

ftp://“IP address of DTS 480x”

to directly reach the sub-directory **/ram**, e.g. Windows file Explorer *ftp://10.241.0.5*

Establish connection as/with a user:

ftp://dts@“IP address of DTS 480x”.

e.g. with Windows file Explorer enter: *ftp://dts@10.241.0.5*

Password: **dts** resp. the defined password for the menu.

To directly reach the sub-directory **/ram**, you can also enter

ftp://dts@10.241.0.5/ram.

Establish connection with IPv6:

The address **must** be written in brackets []:

e.g. with Windows file Explorer enter: *ftp://dts@[fd03:4432:4646:3454::2000]*



Attention: The file has to be copied in **binary mode** (not ASCII).

FTP-Tools

	Windows 7, 8, 10, 11	Linux (Suse, Redhat)
Integrated in the system (file manager):	Windows File Explorer <i>Start → Execute: Explorer</i>	Konqueror
Programs (examples)	CuteFTP	Kbear

8.8 SFTP Connection

SFTP = SSH File Transfer Protocol

SFTP-Tools

	Windows 7, 8, 10, 11	Linux (Suse, Redhat)
Integrated in the system (file manager):	-	Konqueror
Programs (examples)	WinSCP	-

8.9 SCP Connection

SCP = Secure Copy Protocol



Important: SCP connection can only be established when no menu (operation) is open.

The following error message can be ignored. There is no influence in the functionality of the operation:

```
Command 'groups'  
failed with termination code 127 and error message  
-sh: groups: not found.
```

SCP-Tools

	Windows 7, 8, 10, 11	Linux (Suse, Redhat)
Integrated in the system (file manager):	-	With command line
Programs (examples)	WinSCP	-

8.10 Save configuration externally

(for backup or copy to another DTS 480x)

Save the current configuration via MOBA-NMS:

1. Select DTS device in the device view.
2. Menu 'Edit' → Select 'Backup configuration...'
3. Select the elements that are to be saved. (In case of doubt, select everything)
4. Click button 'Next >'.
5. Indicate destination file by clicking the 'Browse...' button.
6. Optionally: enter a free backup comment. E.g. reason for the backup, use, etc. This comment will then be shown during the restoration of the backup.
7. By clicking the 'Finish' button, the backup is created.
8. At the end of the backup, an overview of the process is shown. It shows which elements were saved and which ones are not available or could not be saved.

Save the current configuration via FTP:

1. Connect a FTP client software to the DTS 480x (with Windows file Explorer enter: **ftp://dts@[IP address]**) (as user dts).
2. Change to the DTS 480x directory **/etc**.
3. Save the file **dtsdevice.conf** (configuration) to the user PC (e.g. copy the file to the Desktop or to the directory *My Documents*).
4. Additionally also save possible telegram and program files from the DTS 480x directory **/var/local/dts**.

Save the current configuration via USB-Stick:

The whole procedure can be analogously done with an USB stick. The copy procedure to the USB stick can be started on DTS 480x by selecting the menu '3. Maintenance' → '3. Backup configuration and log to USB' and press ENTER. All files (including program and telegram files) will be copied into the root directory of the USB stick.

Copy configuration to an other DTS 480x:

In order to copy the entire configuration or elements of it from a DTS device to another, the according assistant in MOBA-NMS can be used. For this, select the source device (from which the configuration shall be transferred) and start the assistant in the menu 'Edit' → 'Transfer configuration...'. It will lead you through the individual steps.

Without MOBA-NMS, perform the procedure explained in chapter 8.4 resp. 8.6 .

Important: When copying the configuration from one DTS 480x to an other, the IP address may have to be changed after the download by serial connection



8.11 Copying Telegram or Program files to the DTS 480x.masterclock

Analogously to the previously described procedures telegram and program files can be copied via FTP (*/ram* directory) or USB stick to the DTS 480x.

The copy procedure can be started by selecting the menu '3. Maintenance' → '8. Copy telegram- and program-files' and press ENTER.

The files are stored in the directory */var/local/dts* by the device and can be deleted or copied via FTP.

In addition to the program files (*.prg), *.mbs3 files (SwitchEditor) can also be copied to the device and also be read again later from there.

Special case USB stick:

If the DTS recognizes the insertion of an USB stick, it is shown on the display. By pressing the red button the copy procedure can be released (analogously to the above described procedure). For this, the button has to be pressed until the copy procedure is started.

Management with MOBA-NMS:

With MOBA-NMS, the files do not need to be copied manually via FTP or USB stick, since this is integrated in the MOBA-NMS operation. At every file selection, the 'Change...' link can be clicked. This opens a file dialog which shows all files and allows new files to be loaded onto the device or existing ones to be deleted.

Example of a program file choice:

Programmdatei: [Ändern...](#)

Link for opening the file dialog for editing the file list.

Important: After the file copy procedure, the output of the telegram files and the treatment of the switch programs are re-started (take over of the files).

Important: The **file name** is limited to **8 characters** before the dot, e.g. **IF482Std.tel**.



9 Time administration

9.1 Concept of time administration

The internal master clock time of the DTS 480x is based on UTC (Universal Time Coordinated). The synchronisation inputs, the time shown on the display, as well as all outputs are linked via a time zone entry with the internal master clock time, i.e. all inputs and outputs can be individually allocated to a specific time zone.

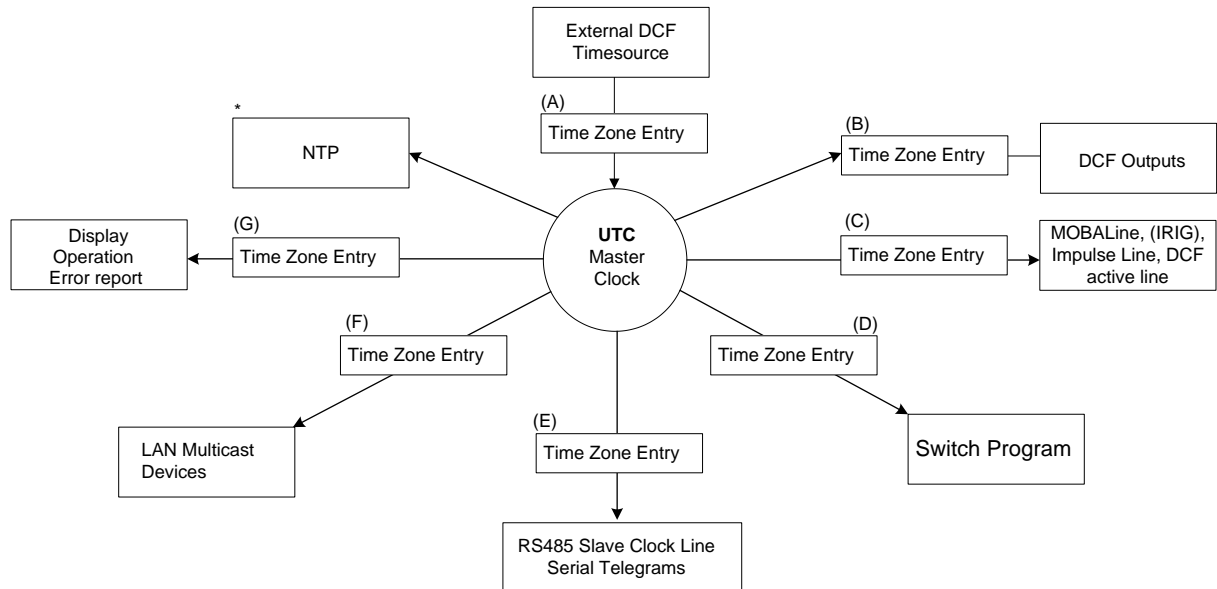

Configurable time zones:

- (A) Chapter 6.5.14 Time source
- (B) Chapter 6.5.7 DCF / Pulse output
- (C) Chapter 6.5.2 MOBALine,
Chapter 6.5.4 Impulse line,
Chapter 6.5.3 IRIG-B, AFNOR (DTS 4803 only),
Chapter 6.5.5 DCF active code line
- (D) Chapter 6.5.11 Switch function / Switch program
- (E) Chapter 6.5.8 Serial telegrams,
Chapter 6.5.9 RS 485 Clock line
- (F) Chapter 6.5.10 NTP slave clocks / Time zone server
- (G) Chapter 6.5.23 General settings
- * NTP is always UTC

9.2 Overview of NTP

Generally NTP as per RFC 5905 (RFC 1305).

- Reference clock for DCF/GPS and internal time
- Up to 4 NTP sources (peers)

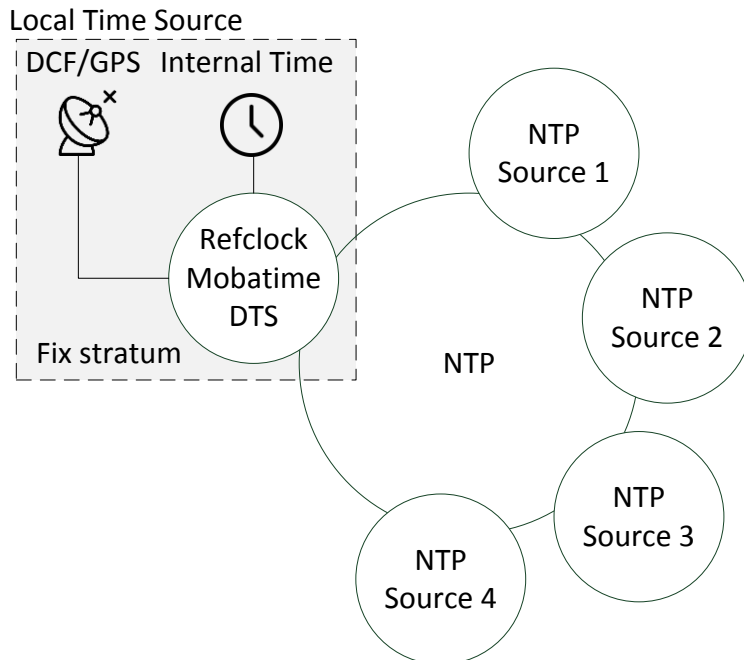

The reference clock can be configured as follows:

- DCF/GPS reception
- Internal time without DCF/GPS reception
- Off

Each time source as well as the DTS 480x device itself has a **stratum value** (RFC 5905). The stratum value of the device corresponds to the stratum value of the time source + 1. If no time source is available, stratum value of the device equals to 16 (unsynchronized).

9.3 Fix stratum for local time source synchronizing multicast clocks

In operation with NTP time sources and the parameter "Local time source = off", the behaviour of the NTP server is that of a standard NTP server (chapter 9.4.3). When the time sources are no longer available or invalid, the NTP server becomes unsynchronized (stratum = 16) after a short time as per NTP algorithm.

To provide **multicast NTP** for slave clock lines, the NTP server has to remain synchronized. An unsynchronized server does not send out any time. The slave clocks in this case will run to the 12 o'clock position.

Therefore, in this case it is recommended to set the **Fix stratum** value **unequal to 0**. If only NTP time sources are in use for the synchronization of the DTS 480x (chapter 9.4.4), set the local time source to **internal**, if DCF/GPS synchronization is being used (chapter 9.4.1, 9.4.2), set the local time source to **DCF/GPS**.

9.4 Configuration and Use Cases

The configuration is done according to chapter 6.5.12 et seq. Each change of the configuration triggers a restart of NTP. If the time source changes from one to another, the DTS 480x may lose its synchronization for a short time.

9.4.1 DCF/GPS with NTP

Use case: system with DCF/GPS reception and 1 up to 4 NTP time sources. The NTP sources serve as a backup, if DCF/GPS reception is lost. If the system must stay synchronized even if NTP or DCF/GPS reception are not available, a fixed stratum value has to be set > 0.



Important: The behaviour as described in this section is only true if qualitatively good time sources are used. This is especially the case for DCF 77 signals. The following products are recommended for synchronization: GPS 4500, DCF 4500, GNSS 3000 or synchronization with a synthetic DCF signal generated by another timeserver/masterclock. For information on the latest products, visit www.mobatime.com.

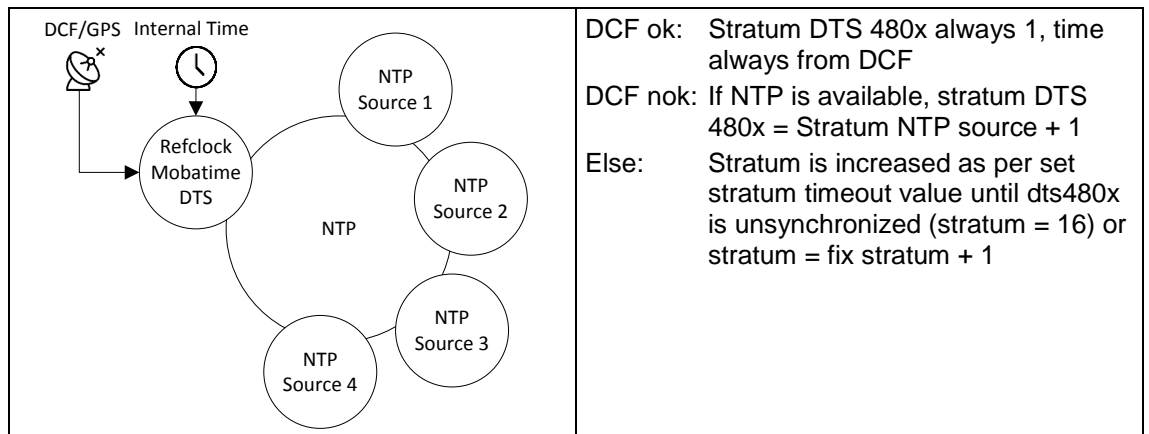

9.4.2 DCF/GPS without NTP

Use case: system with DCF/GPS reception without NTP time sources. If the system must stay synchronized even if DCF/GPS reception is not available, a fixed stratum value has to be set > 0.

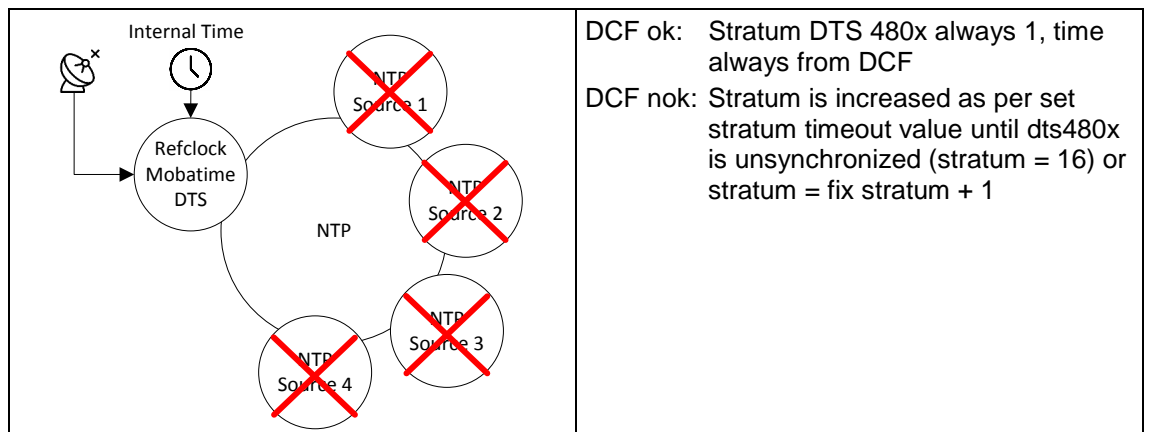

9.4.3 Off with NTP (standard NTP server RFC 5905)

Use case: system with standard NTP behaviour (without local time source). Up to 4 NTP servers can be configured. Configuration of the fix stratum doesn't have any influence on the behaviour of the NTP server.

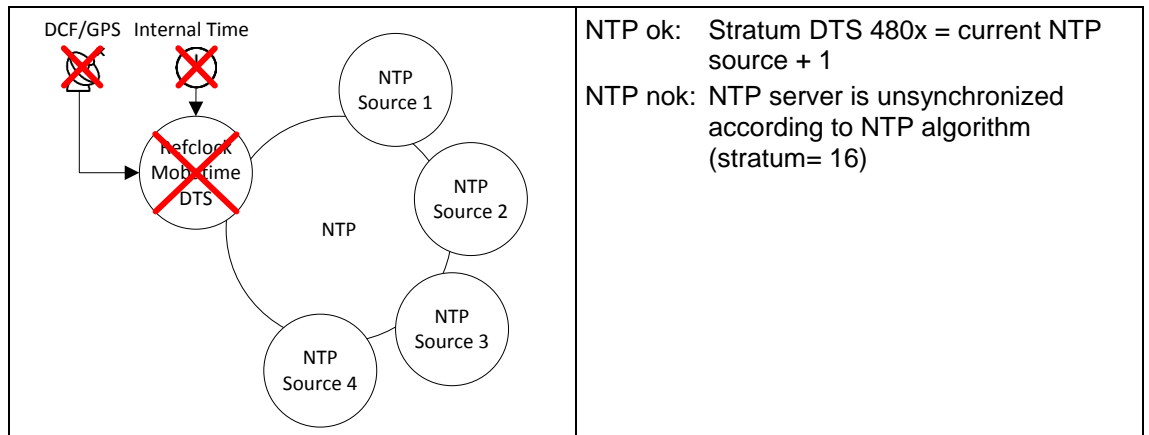

9.4.4 Internal with NTP

Use case: system with standard NTP behaviour but with the option to set a fix stratum value. Up to 4 NTP servers can be configured.

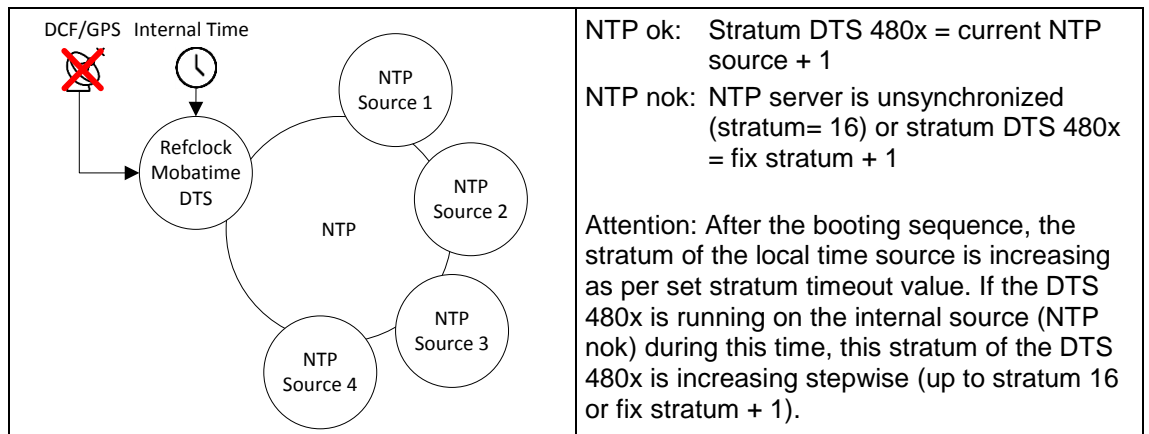

Important: Always set a fix stratum if the local time source is set to internal. Otherwise the behaviour is not defined. If no fix stratum is used, set the local time source to off (chapter 9.4.3).

9.4.5 Internal without NTP

Use case: only for testing purpose of a system with a DTS 480x with valid time but without any time source.

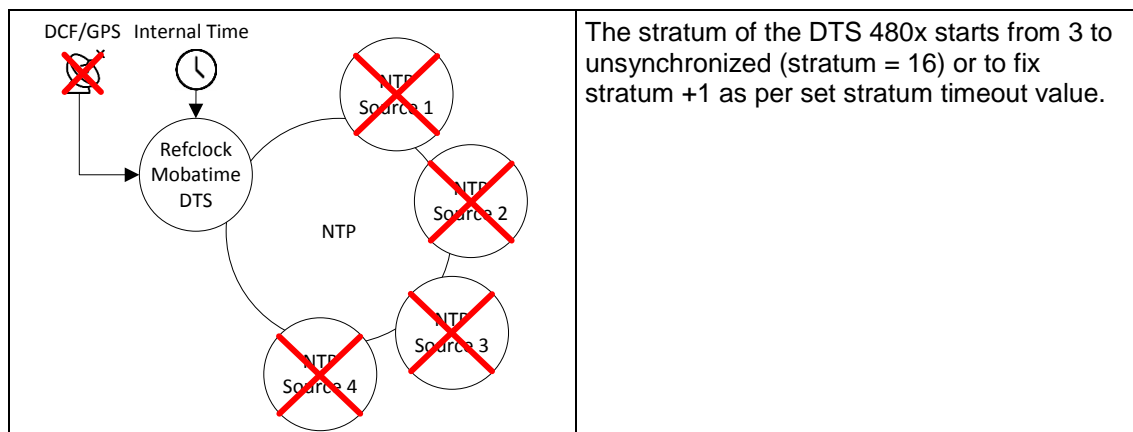

9.5 Time take over

Time take-over from DCF:

- At least 3 minutes of DCF reception are required before the NTP server is available when used with DCF synchronization.
Stratum of the time source = 0 → Stratum of DTS 480x = 1.

Time take-over from NTP:

- As per NTP RFC 5905 (www.ntp.org)
(see <http://support.ntp.org/bin/view/Servers/WebHome> for servers on internet)

Time take-over from RTC (internal time):

- The NTP server is started with stratum 3, if the local time source is not switched off (source type = internal or DCF/GPS). As soon as a time source delivers the time, the stratum is set accordingly.
If there is no local time source configured (source type = off), the NTP server will only start when it receives the time from another NTP server.

Manual time setting:

- The NTP server is started with stratum 3, if the local time source is not switched off (source type = internal or DCF/GPS). As soon as a time source delivers the time, the stratum is set accordingly.
If there is no local time source configured (source type = off), the NTP server will only start when it receives the time from another NTP server.

Error cases:

- **DCF failure:**
Depending on the setting of the "Stratum TO (Timeout)", the stratum will be counted upwards, till it reaches 16.
When the stratum reaches the value "Stratum limit for synchalarm", the alarm "Failure time source Str" occurs (fix delay of 1 min) and the sync LED turns off.
When the time source is available again, the stratum will immediately be set according to the time source (stratum time source + 1).
- **DCF failure with NTP as backup time source:**
Depending on the setting of the "Stratum TO (Timeout)", the stratum will be counted upwards, till it reaches 16.
In case the stratum limit is reached and a NTP server with a better stratum is

available, the DTS 480x synchronizes from NTP.
When the time source is available again, the stratum will immediately be set according the time source (stratum time source + 1).

- **NTP failure:**

The failure of the/all NTP source/s without a defined fix stratum and without DCF. Normally, it takes 8 * the poll intervall of the current source until the peer is recognized as invalid (source can no longer be reached) and NTP loses synchronization. The length of time, with the exception of the poll interval, also depends on the jitter measured, number of sources, length of synchronization and source deviation, and can thus deviate enormously in individual cases.

Exception for time take-over:

After a software update, the first time take over can last distinctly longer (> 8 minutes).

9.6 Time server

- NTP v4 (compatible with v3) as per RFC 1305, RFC 5905 (Port 123)
NTP Authentication with MD5 Key / Autokey
- SNTP (UDP), RFC2030 (Port 123)
- TIME (TCP/UDP), RFC 868 (Port 37)
- DAYTIME (TCP/UDP), RFC 867 (Port 13)

9.7 Time accuracy, time-keeping

See Appendix H Technical data.

9.8 Leap second

Manual mode

Notification of the leap second is always issued 1 hour before the period of time set via DCF and NTP*.

*Notification is only transmitted via NTP if the local source is not switched off (local source = internal or DCF/GPS). If only a NTP source/s is configured (local source = off), the state of the source will be passed on.

Automatic mode

In automatic mode, the source is checked for 1 hour before the time of the possible leap second (DCF or NTP) for any possible notification. If notification is recognized, it will be passed on via NTP and DCF output and the leap second added.

9.9 NTP Authentication

NTP provides two variants for authentication in version 4:

- NTP symmetric keys (i.e. symmetric keys)
- NTP autokeys

NTP authentication assures a correct time source and prevents manipulation of NTP information. NTP data itself is, however, not coded.

9.9.1 NTP symmetric keys

A 32-bit key ID and a cryptographic 64/128-bit hash value of the packet is attached to each NTP IP packet.

The following algorithms are used for this purpose:

- Data Encryption Standard (DES)
(partly restricted in North America and no longer integrated into new NTP variants (>V4.2))
- Message Digest (MD5)

The DTS 480x only supports the MD5 procedure.

The receiving NTP service calculates the hash value with an algorithm and compares it with the one contained in the packet. Both NTP services must have the same encryption key and the same corresponding key ID for this purpose.

Packets with a wrong key or wrong hash value will not be used for synchronization .

The DTS 480x must be correspondingly configured to be able to use NTP authentication (chapter 6.5.15 NTP Server). The NTP service of the other equipment (e.g. server, PC...) must also be configured. In the case of standard NTP, this occurs via the ntp.conf file:

```
# path for key file
keys /etc/ntp/ntp.keys
trustedkey 1 2 3 4 5 6# define trusted keys
requestkey 4 # key (7) for accessing server variables
controlkey 5 # key (6) for accessing server variables

server ntp1.test.org key 2
server ntp2.test.org key 6
server 192.168.23.5 key 3
```

The description of the ntp.conf file can be accessed via the corresponding man-page, or consulted at <http://www.eecis.udel.edu/~mills/ntp/html/authopt.html>

The authentication mode is automatically activated when a key is used and the paths for the keys have been correspondingly configured.

`trustedkey` defines all keys currently permitted

`requestkey` defines the key for the ntpc help tool.

`controlkey` defines the key for the ntpdq help tool.

The keys are located in the ntp.keys file defined with `keys`. This has the following format:

```
1    M    TestTest
2    M    df2ab658
15   M    I_see!
498  M    NTPv4.98
```

The key ID is in the first column of the file, the format of the keys in the second defined column, and the key itself in the third. There are four key formats, however, nowadays only the MD5 is still used → M. The letter M is no longer written for new NTP variants (>V4.2) and is only necessary for backwards compatibility.

The signs ' ', '#', '\t', '\n' and '\0' are not used in the MD5 ASCII key! Key 0 is reserved for special purposes and should, therefore, not be used here.

ntp.keys: man page for ntp.keys to be noted (check the internet)

9.9.2 NTP Autokey

The validity of the time received to the NTP clients is assured by symmetric keys. For a higher degree of certainty, exchanging the keys used regularly is, however, necessary to obtain protection, e.g. from replay attacks (i.e. attacks in which recorded network traffic is simply played back).

The autokey procedure was introduced as the exchange is very involved in a large network. A combination of group keys and public keys enables all NTP clients to check the validity of the time information which they receive from servers in their own autokey group.

NTP Autokey is relatively complex in its use and studying the functionality is definitely necessary beforehand.

Autokey is described at <http://www.cis.udel.edu/~mills/proto.html> or on the NTP homepage <http://www.ntp.org>.

Autokey is currently defined in an IETF draft.

<http://www.ietf.org/internet-drafts/draft-ietf-ntp-autokey-04.txt>

The configuration of Autokey is explained in

<http://support.ntp.org/bin/view/Support/ConfiguringAutokey> or in

<http://www.ntp.org/ntpfaq/NTP-s-config-adv.htm#S-CONFIG-ADV-AUTH>.

10 SNMP

10.1 General

The SNMP version **V2c** or **V3** for *Get*, *Set* and **V1** or **V2c** for *Notification* (Trap) is used.

A full SNMP agent is implemented on the DTS 480x.masterclock (MIB II, DTS480x).

For SNMP V2c, following standard *Communities* are used:

Read only: *romobotime*
Read/write: *rwmobotime*
Trap: *trapmobotime*

For SNMP V3, following standard *User / Passwords* are used:

dtsUser1: *mobotime*
dtsUser2: *mobotime*
dtsInfo: *mobotime* (*not changeable, read only*)

DtsUser1 and dtsUser2 have full read/write access on all objects. With SNMP V3 rules, access can be reduced. But the access can be restricted with corresponding SNMP V3 rules.

SNMP V3 agent supports user validation (authentication MD5) and encoding (encryption DES).

The following MIB definitions are used:

SNMPv2-SMI, SNMPv2-MIB, SNMPv2-CONF, SNMPv2-TC, SNMPv2-TM,
SNMP-FRAMEWORK-MIB, SNMP-MPD-MIB, SNMP-NOTIFICATION-MIB,
SNMP-TARGET-MIB, SNMP-USER-BASED-SM-MIB, SNMP-VIEW-BASED-ACM-MIB,
RFC1213-MIB, IF-MIB, IP-MIB, IP-FORWARD-MIB, TCP-MIB, UDP-MIB,
HOST-RESOURCES-MIB, HOST-RESOURCES-TYPES, DISMAN-EVENT-MIB,
NOTIFICATION-LOG-MIB, UCD-SNMP-MIB, NET-SNMP-MIB, NET-SNMP-TC

SNMP V2c,V3:

DTS-COMMON (File: DTS-COMMON-MIB.TXT)

 General DTS definition, always required

DTS480x (DTS480x-MIB.TXT)

 Device specific DTS definitions

The MIB files can be copied from the DTS 480x.masterclock with FTP (for FTP use, see chapter "8.7 FTP Connection"):

DTS-MIB: /etc/snmp/mibs/

Standard MIBS: /usr/share/snmp/mibs/

10.2 Device configuration with SNMP

If one or several variables are set with *Put* in a configuration group, the variable *dts480x????ConfigCmd* must be set at the end to 1 in the corresponding group. The values of the entire configuration group are assumed from the DTS with this command (1=accept).

As long as the accept command has not been set, the changed variables can be restored to the old values by setting the *dts480x????ConfigCmd* variable to 2 (2=undo, restore).

After sending the accept command, a *dts480xConfigChanged Notification* is sent.

The definitions of the available variables can be taken from the MIB files and from the menu descriptions of this manual.

Example:

Management System		DTS
<i>Put</i> dts480xFTPMode=1	→	Variable is set to 1 internally
<i>Put</i> dts480xNetServicesConfigCmd=1	→	Configuration group is assumed
	←	Sends <i>dts480xConfigChanged Notification</i> with the new time <i>dts480xNetConfigChangedTime</i>

10.3 DTS Subagent SNMP Notification

Protocol: SNMPv2c Notification

Important: For *Notifications* to be sent out, SNMP must be switched on. In addition, at least one receiver system must be configured.

10.3.1 Startup

[dts480xStartUp]

Sent out when the subagent for the DTS is started.

This *Notification* is always sent out, as soon as SNMP is activated and a destination address is configured.

10.3.2 Shutdown

[dts480xShutdown]

Sent out when the subagent for the DTS is stopped.

This *Notification* is always sent out, as soon as SNMP is activated and a destination address is configured.

10.3.3 Status changed

[dts480xStatusChanged]

Sent out when the subagent detects a status change in the DTS application process. The following variables are monitored for changes:

dts480xSysStatus, dts480xSysTimeSource, dts480xSysStratum, dts480xSysMasterMode

This *Notification* is always sent out, as soon as SNMP is activated, and a destination address is configured.

The *Notification* sent out contains the following data:

Field	Type	Size	Description	Example
dts480xSysStatus	Unsigned Int	4 Bytes	Contains the internal system status	66309
dts480xSysOffset	Integer	4 Bytes	Actual time offset of the system [us]	-1523 → -1.523ms
dts480xSysTimeSource	Byte	1 Bytes	Actual time source	2
dts480xSysStratum	Byte	1 Bytes	Actual system stratum level	1

10.3.4 Configuration changed

[dts480xConfigChanged]

Sent out when the subagent detects a configuration change in the DTS application processes.

This *Notification* is always sent out, as soon as SNMP is activated and a destination address is configured.

The *Notification* sent out contains the following data:

Field	Type	Size	Description
dts480xSysConfigChangedTime	TimeTicks	4 Bytes	dts480xSystem
dts480xNetConfigChangedTime	TimeTicks	4 Bytes	dts480xNetwork
dts480xNetServicesConfigChangedTime	TimeTicks	4 Bytes	dts480xNetServices
dts480xTSConfigChangedTime	TimeTicks	4 Bytes	dts480xTimeSource
dts480xNTPConfigChangedTime	TimeTicks	4 Bytes	dts480xTimeNTPServer
dts480xOutLineClock1ConfigChangedTime	TimeTicks	4 Bytes	dts480xOutLineClock1
dts480xOutLineClock2ConfigChangedTime	TimeTicks	4 Bytes	dts480xOutLineClock2
dts480xOutLineClock3ConfigChangedTime	TimeTicks	4 Bytes	dts480xOutLineClock3
dts480xOutLineClock4ConfigChangedTime	TimeTicks	4 Bytes	dts480xOutLineClock4
dts480xOutLineClock5ConfigChangedTime	TimeTicks	4 Bytes	dts480xOutLineClock5
dts480xOutLineClock6ConfigChangedTime	TimeTicks	4 Bytes	dts480xOutLineClock6
dts480xOutLineDCFConfigChangedTime	TimeTicks	4 Bytes	dts480xOutLineDCF
dts480xOutLineSerialConfigChangedTime	TimeTicks	4 Bytes	dts480xOutLineSerial
dts480xOutLineTZServerConfigChangedTime	TimeTicks	4 Bytes	dts480xOutLineTZServer
dts480xOutLineSwitchConfigChangedTime	TimeTicks	4 Bytes	dts480xOutLineSwitchFct
dts480xRelayConfigChangedTime	TimeTicks	4 Bytes	dts480xAlarmRelayConfig
dts480xMailConfigChangedTime	TimeTicks	4 Bytes	dts480xAlarmMailConfig
dts480xSnmpConfigChangedTime	TimeTicks	4 Bytes	dts480xSnmpConfig
dts480xSystemVoltageChangedTime	TimeTicks	4 Bytes	dts480xSystemVoltageConfig

The *ConfigChangedTime* variables show the time (TimeTicks value 1/100 seconds) of the last change of the relevant configuration group. The management system can decide on the basis of these time values, which configurations need to be reloaded.

Configuration group table

Configuration group	Variable
dts480xSystem	dts480xLanguage dts480xTimezone dts480xPassword dts480xDisplayTimezone dts480xDisplayTimeFormat
dts480xNetwork	dts480xIPAddr dts480xIPMask dts480xIPGateway dts480xIPNameserver dts480xHostname dts480xDomain dts480xDHCPMode dts480xEthernetLinkMode dts480xIPv6AutoConf dts480xIPv6DHCPMode dts480xIPv6Addr1 dts480xIPv6Prefix1 dts480xIPv6Gateway1 dts480xIPv6Addr2 dts480xIPv6Prefix2 dts480xIPv6Gateway2 dts480xIPv6Nameserver
dts480xNetServices	dts480xTelnetMode dts480xFTPMode dts480xSSHMode
dts480xTimeSource	dts480xTSLocalMode dts480xTSLocalTimezone dts480xTSLocalTimeout dts480xTSLocalFixStratum dts480xTSLocalCorrection dts480xTSLocalStratumTimeou dts480xTSOffsetSynchOnly dts480xTSErrorStratum dts480xTSLeapSecMode dts480xTSLeapSecDate dts480xTSCanMode
dts480xTimeNTPServer	dts480xNTPBroadcastAddr1 dts480xNTPBroadcastInterval1 dts480xNTPBroadcastTTL1 dts480xNTPBroadcastKey1 dts480xNTPBroadcastAddr2 dts480xNTPBroadcastInterval2 dts480xNTPBroadcastTTL2 dts480xNTPBroadcastKey2 dts480xNTPSourceTable (1..4) (dts480xNTPSourceAddr dts480xNTPSourceMinPoll dts480xNTPSourceMaxPoll dts480xNTPSourceMode dts480xNTPSourcePrefer dts480xNTPSourceKey)
dts480xTimeManualSet	dts480xManualTimeSetUTC dts480xManualTimeSetDiff
dts480xOutLineClockx x=[1...6]	dts480xOutLineClockxType dts480xOutLineClockxMode dts480xOutLineClockxTimezone dts480xOutLineClockxAICurrent dts480xOutLineClockxMBLFunction

	dts480xOutLineClockxMBLSwitch dts480xOutLineClockxMBLWorldtime dts480xOutLineClockxMBLTZTable (1..20) (dts480xOutLineClockxMBLTZTableEntryNumber) dts480xOutLineClockxImpFunction dts480xOutLineClockxImpLinetime dts480xOutLineClockxImpWidth dts480xOutLineClockxImpPause dts480xOutLineClockxImpCatchUp
dts480xOutLineDCFMode	dts480xOutLineDCFMode dts480xOutLineDCFTimezone dts480xOutLineDCFPulseType dts480xOutLineDCFPulseTime dts480xOutLineDCFPulsePeriod dts480xOutLineDCFPulseCorrection dts480xOutLineDCFConfigCmd
dts480xOutLineSerial	dts480xOutLineSerialMode dts480xOutLineSerialTimezone dts480xOutLineSerialComMode dts480xOutLineSerialComParam dts480xOutLineSerialTeleFile dts480xOutLineRS485Mode dts480xOutLineRS485Devices dts480xOutLineRS485DevNameTable(1..32) (dts480xOutLineRS485DevName) dts480xOutLinesRS485Switch
dts480xOutLineTZServerConfigChangedTime	dts480xOutLineTZServerMode dts480xOutLineTZServerMCastAddr dts480xOutLineTZServerMCastPort dts480xOutLineTZServerNTPInterval dts480xOutLineTZServerTTL dts480xOutLineTZServerTableInterval dts480xOutLineTZServerEntryInterval dts480xOutLineTZServerTable (1..15) (dts480xOutLineTZTableEntryNumber)
dts480xOutLineSwitchFct	dts480xOutLineSwitchTimezone dts480xOutLineSwitchProgFile dts480xOutLineSwitchFctChannel dts480xOutLineSwitchFctComb dts480xOutLineSwitchFctLongitude dts480xOutLineSwitchFctLatitude dts480xOutLineSwitchFctLeadSun1 dts480xOutLineSwitchFctFolSun1 dts480xOutLineSwitchFctLeadSun2 dts480xOutLineSwitchFctFolSun2 dts480xOutLineSwitchFctState dts480xOutLineSwitchInpChan1 dts480xOutLineSwitchInpComb1 dts480xOutLineSwitchInpChan2 dts480xOutLineSwitchInpComb2 dts480xOutLineSwitchInpChan3 dts480xOutLineSwitchInpComb3 dts480xOutLineSwitchInpChan4 dts480xOutLineSwitchInpComb4 dts480xOutLineSwitchState dts480xOutLineSwitchLockState dts480xOutLineSwitchCmdChannel dts480xOutLineSwitchCmdFunction
dts480xRelayConfigChangedTime	dts480xRelayAlarmMask
dts480xMailConfigChangedTime	dts480xMailMode dts480xMailAlarmMask dts480xMailServerIPAddress dts480xMailServerPort dts480xMailAddrDestination1

	dts480xMailAddrDestination2 dts480xMailAddrReply dts480xMailAddrFrom dts480xMailUser dts480xMailPassword dts480xMailAuthMode
dts480xSnmpConfigChangedTime	dts480xSnmpMode dts480xSnmpAlarmMask dts480xSnmpROCommunity dts480xSnmpRWCommunity dts480xSnmpTrapMode dts480xSnmpTrapAlarmMask dts480xSnmpTrapCommunity dts480xSnmpTrapListenerIPAddress1 dts480xSnmpTrapListenerPort1 dts480xSnmpTrapVersion1 dts480xSnmpTrapListenerIPAddress2 dts480xSnmpTrapListenerPort2 dts480xSnmpTrapVersion2 dts480xSnmpTrapAliveMsgInterval dts480xSnmpLocation dts480xSnmpContact dts480xSnmpV3UserPassword1 dts480xSnmpV3UserLevel1 dts480xSnmpV3UserRead1 dts480xSnmpV3UserWrite1 dts480xSnmpV3UserPassword2 dts480xSnmpV3UserLevel2 dts480xSnmpV3UserRead2 dts480xSnmpV3UserWrite2 dts480xSnmpV3View11 dts480xSnmpV3View12 dts480xSnmpV3View13 dts480xSnmpV3View14 dts480xSnmpV3View15 dts480xSnmpV3View16 dts480xSnmpV3View21 dts480xSnmpV3View22 dts480xSnmpV3View23 dts480xSnmpV3View24 dts480xSnmpV3View25 dts480xSnmpV3View26
dts480xSystemVoltageChangedTime	dts480xSystemVoltage dts480xSystemVoltageType dts480xSystemVoltageConfigMode

10.3.5 Alive Notification

[dts480xAlive]

Sent out in a configurable interval.

This *Notification* is always sent out, as soon as SNMP and the alarm traps are activated and a destination address is configured.

The *Notification* sent out contains the following data:

Field	Type	Size	Description	Example
dts480xSysStatus	Unsigned Int	4 Bytes	Contains the internal system status	66309
dts480xSysAlarms	Byte Array	8 Bytes	64 Bit Alarm flags 1.Byte Bit 0..7 2.Byte Bit 8..15 :: 8.Byte Bit 56..63	FFF870FF.FFFFFFFF 5.Byte 2.Byte 1.Byte

10.3.6 Alarm Notification

[dts480xAlarm]

Sent out if alarm status changes, i.e. *Notification* is sent out when an alarm flag is set or deleted.

This *Notification* is always sent out, as soon as SNMP and the alarm traps are activated and a destination address is configured.

The *Notification* sent out contains the following data:

Field	Type	Size	Description	Example
dts480xTrapAImMsgErrorNr	Byte	1 Bytes	No. of the alarm bit (0..63)	8
dts480xTrapAImMsgErrorState	Byte	1 Bytes	0 = alarm bit was deleted 1 = alarm bit was set	1
dts480xTrapAImMsgErrorTime	Unsigned Int	4 Bytes	PC-time in seconds since 01.01.1970 00:00:00	946684805
dts480xTrapAImMsgErrorText	Text	59 Bytes	Error text	Line current too high

11 Description of the switch function

11.1 General Description

The switch program is composed of 99 week programs and 64 channel programs.

The week programs describe the behaviour during one week, independent of date and channel number. Such a week program can contain numerous lines and each line is composed of time of the day, days of week as well as the switching function to be executed at this moment.

The 3 possible switching functions are: ON, OFF, Signal 01 – 99 Seconds.

Now the channel programs assign the week programs to the channels, which are dependent on the date. Such a channel program can contain several lines. Each line is composed of the starting date and the number of the week program to be used.

Up to 1000 lines can be programmed in this way. This is the total sum of the lines in the week and channel programs.

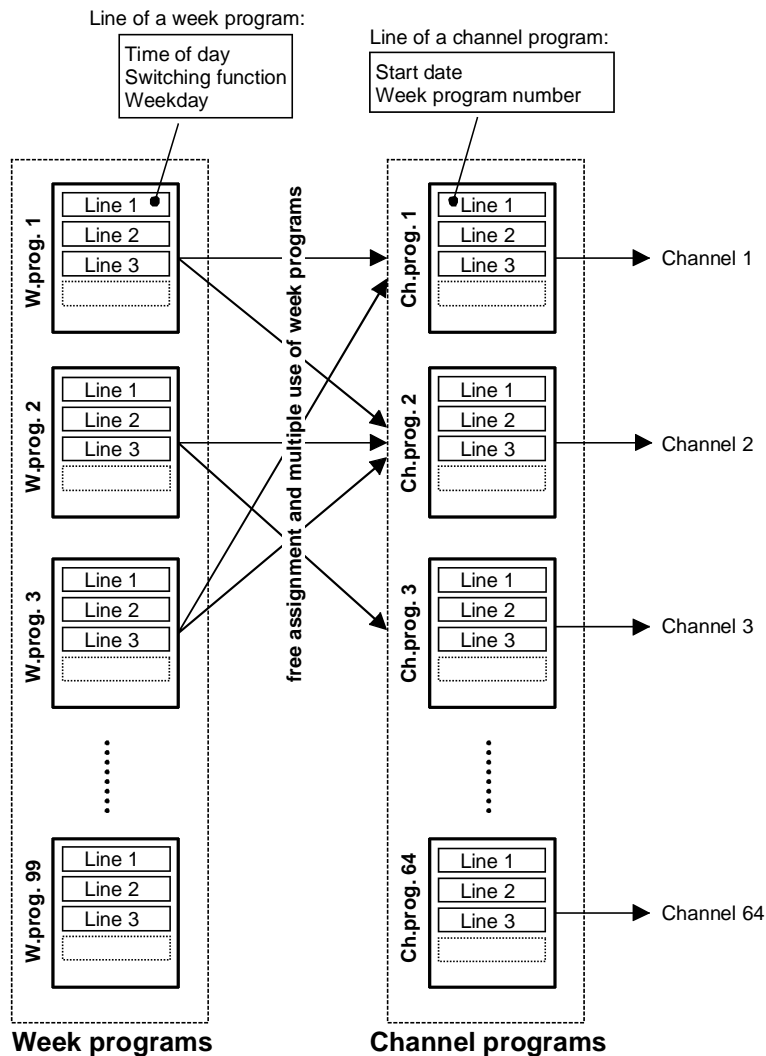

With the PC software "SwitchEditor" the switch programs can be created on a PC and then be downloaded to the DTS 480x via FTP / USB stick.

A maximum of **8 characters** are allowed for the file name of the **switch program file** and its extension is **PRG, Prg or prg**.

Additionally the SwitchEditor project file (mbs3) can be stored on the DTS 480x.

11.2 Combination of the signals

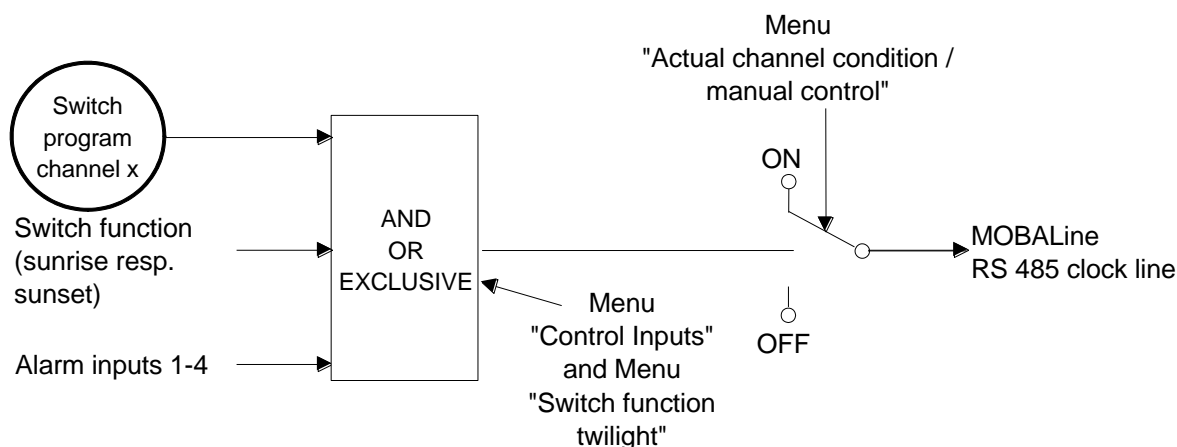

Each of the 4 alarm inputs can as control input or switch input be linked to a channel with AND, OR, or exclusive.

If the control input is exclusive, the switch status is transmitted as quickly as possible via MOBALine (0-10sec).

If the control input AND or OR is linked to the switch program, the status of the input is transferred to the next but one minute.

The switch inputs have priority as opposed to the twilight function:
i.e. if a control input and the twilight function is linked to the same channel, the twilight function is ignored.

If an alarm input is used as switch input, it must be masked in all alarm masks.

11.3 Behavior at start-up, exchange of switch program file

After starting up the DTS 480x, or after changing the program file, it can take up to 2 min until the switch states to the channel relay are correct.



Important: The max. number of signal commands is limited to 15 per minute.

A Connection diagrams

A.1 Front connections

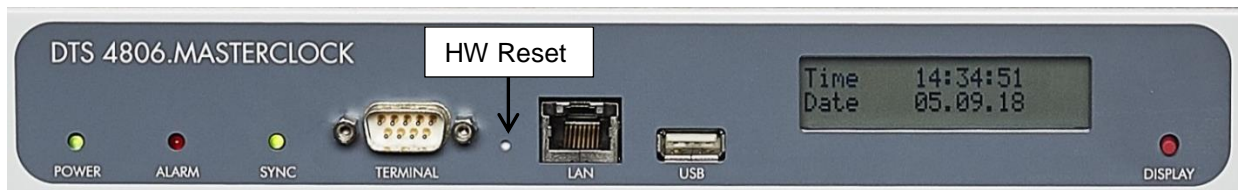

PC - Terminal Connection:

Type of connector: Sub-D 9p connector (male)
Interface: RS232
Baud rate: 38400 Bauds
Data Bits: 8
Parity: no
Stop Bit: 1
Flow control: no

Cable DTS 480x – PC: Crossed cable, female – female connectors (null modem)
(DTE-DTE) Max. length of the connection 3m

Verbindungen zwischen Buchse 1 (SUB-D 9 / 1) and Buchse 2 (SUB-D 9 / 2)

	SUB-D 9 / 1	SUB-D 9 / 2	
Receive Data *	2	3	Transmit Data
Transmit Data *	3	2	Receive Data
Data Terminal Ready	4	1 & 6	Data Set Ready & Carrier Detect
System Ground *	5	5	System Ground
Data Set Ready & Carrier Detect	1 & 6	4	Data Terminal Ready
Request to Send	7	8	Clear to Send
Clear to Send	8	7	Request to Send

* At least needed connections.

LAN Connection:

Plug: RJ45
Interface: Ethernet, 10/100Mbit half or full duplex
Use only shielded cables!

USB Connection:

Plug: USB-Host



Important: Only permitted for the operations with a USB stick!

A.2 Connections (rear view) DTS 4801.masterclock & DTS 4803.masterclock

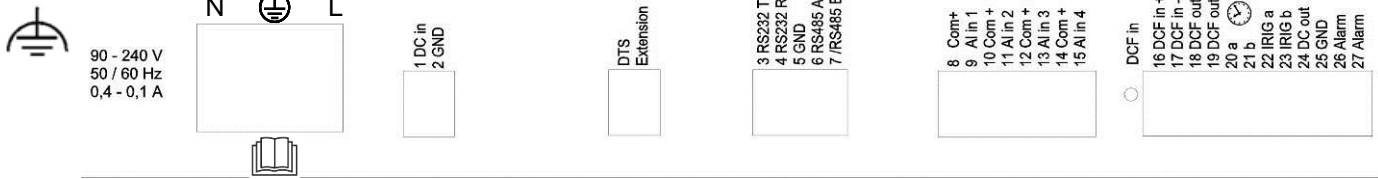

DTS 4801 / 4803 connections

For technical data see in Appendix "H Technical data"

Clamp	Connection	Description
	Earth connection	
L	Mains connection phase	Mains power input with rubber connector
	Mains connection earth	<i>Break point: by disconnecting the rubber connector</i>
N	Mains connection neutral	See Appendix H, section "Mains power supply"
1	DC in power supply +	Input for external DC supply
2	DC in power supply GND	Ground
	DTS Extension	Connection to DTS extension: Connection length max. 0.5m. Do only connections when power is off.
3	RS232 TXD	Output for serial telegrams Connection length max. 30m
4	RS232 RXD*	Input for serial telegrams
5	GND	
6	RS485 A	Output for RS 485 slave clock line / serial telegrams
7	/RS485 B	Output for RS 485 slave clock line / serial telegrams
8	Common +	Alarm inputs: 18-36VDC, max. 6mA current consumption, close contact. Contact closed → no alarm. Length of connection max. 30m.
9	Alarm input 1	
10	Common +	
11	Alarm input 2	
12	Common +	
13	Alarm input 3	
14	Common +	
15	Alarm input 4	
16	DCF input +	DCF input e.g. for the connection of a GPS 4500 or DCF receiver with current loop output.
17	DCF input -	
18	DCF output +	DCF or pulse output, current loop passive, $U_{max}=30VDC$, $I_{on} = 10..15mA$, $I_{off} < 1mA @ 20VDC$
19	DCF output -	
20	Slave clock line a	Output for MOBALine, impulse line or DCF active line
21	Slave clock line b	Output for MOBALine, impulse line or DCF active line
22	IRIG a	Output for IRIG-B (only DTS 4803)
23	IRIG b	Output for IRIG-B (only DTS 4803)
24	DC output +	DC output for GNSS / GPS 4500 or RS 485 slave clocks 28 VDC, max. 400 mA
25	DC output GND	
26	Alarm relay	Alarm contact, open when alarm is active
27	Alarm relay	Switching load: 30 W (125 VDC or 1 A), e.g. 1 A @ 30 VDC or 60 VA (150 VAC or 1 A), e.g. 0.5 A @ 120 VAC

* only partly available.

A.3 Connections (rear view) DTS 4802.masterclock

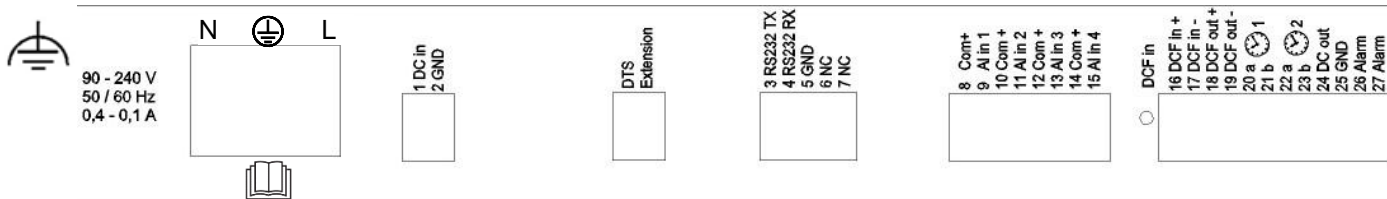

DTS 4802 connections

For technical data see in Appendix "H Technical data"

Clamp	Connection	Description
	Earth connection	
L	Mains connection phase	Mains power input with rubber connector
	Mains connection earth	<i>Break point: by disconnecting the rubber connector</i>
N	Mains connection neutral	See Appendix H, section "Mains power supply"
1	DC in power supply +	Input for external DC supply
2	DC in power supply GND	Ground
	DTS Extension	Connection to DTS extension: Connection length max. 0.5m. Only plug in connections when the power is off.
3	RS232 TXD	Output for serial telegrams Connection length max. 30m
4	RS232 RXD*	Input for serial telegrams
5	GND	
6	NC	Not used
7	NC	Not used
8	Common +	Alarm inputs: 18-36VDC, max. 6mA current consumption, close contact. Contact closed → no alarm. Length of connection max. 30m.
9	Alarm input 1	
10	Common +	
11	Alarm input 2	
12	Common +	
13	Alarm input 3	
14	Common +	
15	Alarm input 4	
16	DCF input +	DCF input e.g. for the connection of a GNSS / GPS 4500 or DCF receiver with current loop output.
17	DCF input -	
18	DCF output +	DCF or pulse output, current loop passive, $U_{max}=30VDC$, $I_{on} = 10..15mA$, $I_{off} < 1mA @ 20VDC$
19	DCF output -	
20	Slave clock line a 1	Output for MOBALine, impulse line 1 or DCF active line 1
21	Slave clock line b 1	Output for MOBALine, impulse line 1 or DCF active line 1
22	Slave clock line a 2	Output for MOBALine, impulse line 2 or DCF active line 2
23	Slave clock line b 2	Output for MOBALine, impulse line 2 or DCF active line 2
24	DC output +	DC output for GNSS / GPS 4500 or RS 485 slave clocks 28 VDC, max. 400 mA
25	DC output GND	
26	Alarm relay	Alarm contact, open when alarm is active
27	Alarm relay	Switching load: 30 W (125 VDC or 1 A), e.g. 1 A @ 30 VDC or 60 VA (150 VAC or 1 A), e.g. 0.5 A @ 120 VAC

* At the moment only partly available.

A.4 Connections (rear view) DTS 4806.masterclock

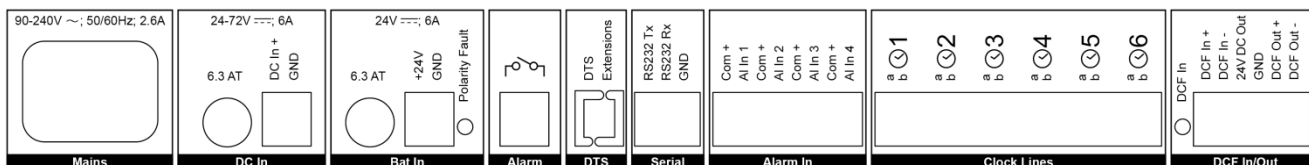

DTS 4806 connections

For technical data see in Appendix "H Technical data"

Clamp	Connection	Description
	Earth connection	
L	Mains connection phase	Mains power input with rubber connector
	Mains connection earth	<i>Break point: by disconnecting the rubber connector</i>
N	Mains connection neutral	See Appendix H, section "Mains power supply"
1	DC in power supply +	Input for external DC supply
2	DC in power supply GND	Ground
3	BAT in power supply +	Input for an external rechargeable battery
4	BAT in power supply GND	Ground
5	Alarm relay	Alarm contact, open when alarm is active
6	Alarm relay	Switching load: 30 W (125 VDC or 1 A), e.g. 1 A @ 30 VDC or 60 VA (150 VAC or 1 A), e.g. 0.5 A @ 120 VAC
	DTS Extension	Connection to DTS extensions: Connection length max. 0.5m. Plug in connections only in dead-voltage state.
7	RS232 TXD	Serial telegram output Connection length max. 30m
8	RS232 RXD*	Serial telegram input
9	GND	
10	Common +	Alarm inputs: 18-36VDC, max. consumption 6mA, contact closing. Contact closed → no alarm Connection length max. 30m.
11	Alarm input 1	
12	Common +	
13	Alarm input 2	
14	Common +	
15	Alarm input 3	
16	Common +	
17	Alarm input 4	
16	Slave clock line a 1	Output for MOBALine, impulse line or DCF active line 1
17	Slave clock line b 1	
18	Slave clock line a 2	Output for MOBALine, impulse line or DCF active line 2
19	Slave clock line b 2	
20	Slave clock line a 3	Output for MOBALine, impulse line or DCF active line 3
21	Slave clock line b 3	
22	Slave clock line a 4	Output for MOBALine, impulse line or DCF active line 4
23	Slave clock line b 4	
24	Slave clock line a 5	Output for MOBALine, impulse line or DCF active line 5
25	Slave clock line b 5	
26	Slave clock line a 6	Output for MOBALine, impulse line or DCF active line 6
27	Slave clock line b 6	

28	DCF input +	DCF input e.g. for connecting a GNSS / GPS 4500 or DCF receiver with „current loop“ output
29	DCF input -	
30	DC output +	DC output for GNSS / GPS 4500 or RS 485 slave clocks 28 VDC, max. 400 mA
31	DC output GND	
32	DCF output +	DCF or impulse output, “current loop” passive, Umax= 30VDC, Ion = 10..15mA, Ioff < 1mA @20VDC
33	DCF output -	

* currently only limited availability.

A.5 Plug-in spring terminals

Multiple contact strip 100% protected against wrong plug;
WAGO CAGE CLAMP®-connection
Cross section of 0,08 mm² to 1,5 mm² (from AWG 28 to AWG 14)
Voltage CSA 300 V / current CSA 10 A
Rated voltage: EN 250 V
Rated surge voltage: 2,5 kV
Nominal current: 10 A
Strip length: 7 mm (0,28 in)



Pulled out spring terminal with operation tool:

2 operation tools are delivered with the accessory bag.

A.6 Connection of GNSS / GPS 4500, DCF 450 / 4500 or GNSS 3000

Connection of DCF or GNSS receiver to DTS 4801 / 4802 / 4803:

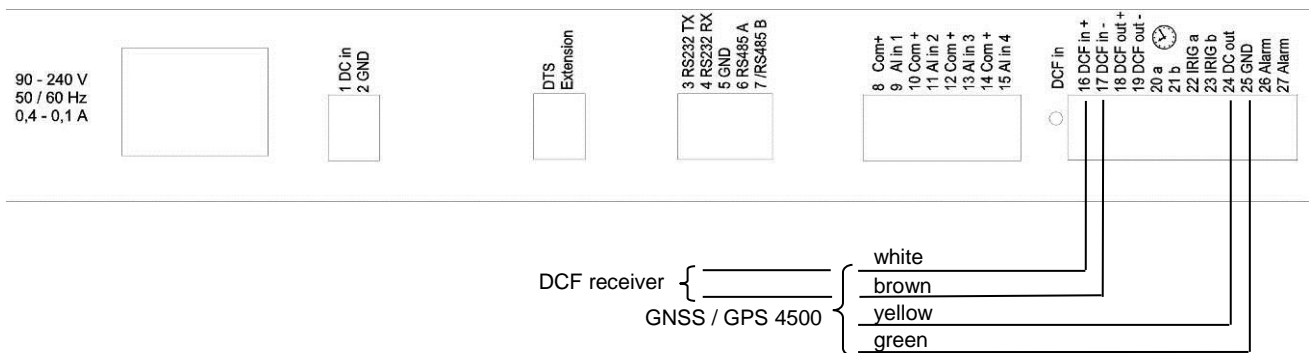

Connection DCF or GNSS receiver DTS 4806:

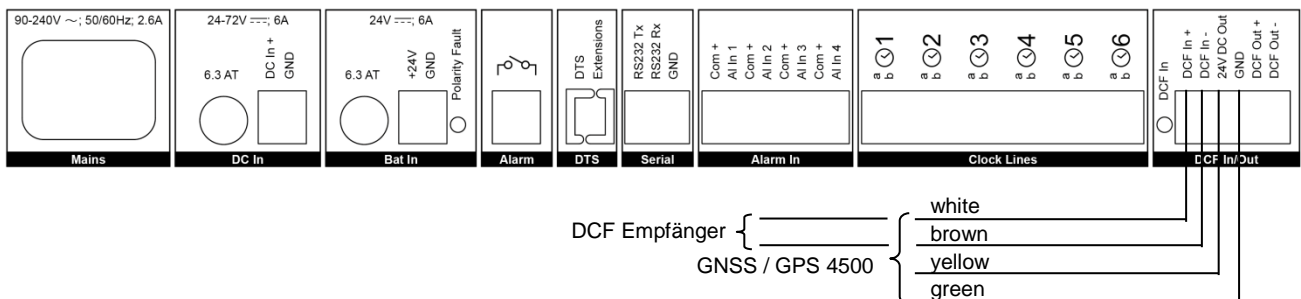

GNSS 3000 according to manual Bx-800813 chap. 9.2 Connection schematics DCF current loop

B Time Zone Table

Time zone entries in the standard season table (version 10.2).

No.	City / State	UTC Offset	DST	Standard → DST	DST → Standard
00	UTC (GMT), Monrovia	0	No		
01	London, Dublin, Lisbon	0	Yes	Last Sun. Mar. (01:00)	Last Sun. Oct. (02:00)
02	Brussels, Amsterdam, Berlin, Bern, Copenhagen, Madrid, Oslo, Paris, Rome, Stockholm, Vienna, Belgrade, Bratislava, Budapest, Ljubljana, Prague, Sarajevo, Warsaw, Zagreb	+1	Yes	Last Sun. Mar. (02:00)	Last Sun. Oct. (03:00)
03	Athens, Helsinki, Riga, Tallinn, Sofia, Vilnius	+2	Yes	Last Sun. Mar. (03:00)	Last Sun. Oct. (04:00)
04	Bucharest	+2	Yes	Last Sun. Mar. (03:00)	Last Sun. Oct. (04:00)
05	Pretoria, Harare, Kaliningrad	+2	No		
06	Amman	+2	Yes	Last Thu. Mar. (23:59)	Last Fri. Oct. (01:00)
07	UTC (GMT)	0	No		
08	Istanbul, Kuwait City, Minsk, Moscow, Saint Petersburg, Volgograd	+3	No		
09	Praia, Cape Verde	-1	No		
10	UTC (GMT)	0	No		
11	Abu Dhabi, Muscat, Tbilisi, Samara	+4	No		
12	Kabul	+4.5	No		
13	Adamstown (Pitcairn Is.)	-8	No		
14	Tashkent, Islamabad, Karachi, Yekaterinburg	+5	No		
15	Mumbai, Kolkata, Chennai, New Delhi, Colombo	+5.5	No		
16	Astana, Thimphu, Dhaka, Novosibirsk	+6	No		
17	Bangkok, Hanoi, Jakarta, Krasnoyarsk	+7	No		
18	Beijing, Hong Kong, Singapore, Taipei, Irkutsk	+8	No		
19	Tokyo, Seoul, Yakutsk	+9	No		
20	Gambier Island	-9	No		
21	South Australia: Adelaide	+9.5	Yes	1 st Sun. Oct (02:00)	1 st Sun. Apr. (03:00)
22	Northern Territory: Darwin	+9.5	No		
23	Brisbane, Guam, Port Moresby, Vladivostok	+10	No		
24	Sydney, Canberra, Melbourne, Tasmania: Hobart	+10	Yes	1 st Sun. Oct. (02:00)	1 st Sun. Apr. (03:00)
25	UTC (GMT)	0	No		
26	UTC (GMT)	0	No		
27	Honiara (Solomon Is.), Magadan, Noumea (New Caledonia)	+11	No		
28	Auckland, Wellington	+12	Yes	Last Sun. Sep. (02:00)	1 st Sun. Apr. (03:00)
29	Majuro (Marshall Is.), Anadyr	+12	No		
30	Azores	-1	Yes	Last Sun. Mar. (00:00)	Last Sun. Oct. (01:00)
31	Middle Atlantic	-2	No		
32	Brasília	-3	Yes	3 rd Sun. Oct. (00:00)	3 rd Sun. Feb. (00:00)
33	Buenos Aires	-3	No		
34	Newfoundland	-3.5	Yes	2 nd Sun. Mar. (02:00)	1 st Sun. Nov. (02:00)
35	Atlantic Time (Canada)	-4	Yes	2 nd Sun. Mar. (02:00)	1 st Sun. Nov. (02:00)
36	La Paz	-4	No		
37	Bogota, Lima, Quito	-5	No		
38	New York, Eastern Time (US & Canada)	-5	Yes	2 nd Sun. Mar. (02:00)	1 st Sun. Nov. (02:00)
39	Chicago, Central Time (US & Canada)	-6	Yes	2 nd Sun. Mar. (02:00)	1 st Sun. Nov. (02:00)

40	Tegucigalpa, Honduras	-6	No		
41	Phoenix, Arizona	-7	No		
42	Denver, Mountain Time	-7	Yes	2 nd Sun. Mar. (02:00)	1 st Sun. Nov. (02:00)
43	Los Angeles, Pacific Time	-8	Yes	2 nd Sun. Mar. (02:00)	1 st Sun. Nov. (02:00)
44	Anchorage, Alaska (US)	-9	Yes	2 nd Sun. Mar. (02:00)	1 st Sun. Nov. (02:00)
45	Honolulu, Hawaii (US)	-10	No		
46	Midway Islands (US)	-11	No		
47	Mexico City, Mexico	-6	Yes	1 st Sun. Apr. (02:00)	Last Sun. Oct. (02:00)
48	Adak (Aleutian Is.)	-10	Yes	2 nd Sun. Mar. (02:00)	1 st Sun. Nov. (02:00)
49	UTC (GMT)	0	No		
50	UTC (GMT)	0	No		
51	UTC (GMT)	0	No		
52	UTC (GMT)	0	No		
53	UTC (GMT)	0	No		
54	Ittoqqortoormiit, Greenland	-1	Yes	Last Sun. Mar. (00:00)	Last Sun. Oct. (01:00)
55	Nuuk, Qaanaaq, Greenland	-3	Yes	Last Sat. Mar. (22:00)	Last Sat. Oct. (23:00)
56	Not used				
57	Western Australia: Perth	+8	No		
58	Caracas	-4.5	No		
59	CET standard time	+1	No		
60	Not used				
61	Not used				
62	Baku	+4	Yes	Last Sun. Mar. (04:00)	Last Sun. Oct. (05:00)
63	UTC (GMT)	0	No		
64	UTC (GMT)	0	No		

In countries where the DST switch date changes annually (e.g. Iran, Israel), the time zone has to be defined manually in the user time zone table (entries 80 – 99).

Legend:

UTC: Universal Time Coordinate, equivalent to GMT
DST: Daylight Saving Time
DST Change: Daylight Saving Time changeover
Standard → DST: Time change from Standard time (Winter time) to Summer time
DST → Standard: Time change from Summer time to Standard time (Winter time)

Example:

2nd last Sun. Mar. (02:00) Switch over on the penultimate Sunday in March at 02.00 hours local time.



Important:

The Time Zone Table is usually updated as needed. The current table is available for download under the following address: www.mobatime.com → Customer Area → Customer Support → Support Resources → Time Zone Table. In case your device is equipped with a newer version than shown in this manual, the current time zone settings should be checked.

Modifications / updating the time zone table:

The time zone tables are filed in the */etc/mbsn.tbl* (standard table) and */etc/usersn.tbl* (user table) files. The user table can be changed with MOBA-NMS or any other Moser-Baer AG software such as, e.g. ETCW. If not changed using MOBA-NMS, it must be updated in accordance with the update instructions (chapter “8.4 Updating applications and configuration via FTP” or 8.6“ Updating applications or configurations via USB)



Important: The file names *mbsn.tbl* and *usersn.tbl* must be written in small letters.

C Alarm List

C.1 Alarms

Number	Error message	Description / Action
0	Alarm input 1	Check device on input 1
1	Alarm input 2	Check device on input 2
2	Alarm input 3	Check device on input 3
3	Alarm input 4	Check device on input 4
4	Error bit4	Not used
5	DTS restart	DTS 480x has been restarted, no action required
6	Failure 5V	Hardware error → Support
7	Supply voltage low	Check DC voltage (DC in).
8	Line 1 current high	Check MOBALine / Impulse line / DCF active line. Alarm disappears only, if error is removed.
9	Wrong time zone Line 1	Check time zone setting in (MOBALine / Impulse line / DCF active line)
10	Wrong time zone DCF out	Check time zone setting in (DCF- / pulse output)
11	Wrong time zone RS485	Check time zone setting in (RS485 output / serial telegrams)
12	Error IRIG output	Only in DTS 4803: Check IRIG line.
13	Telegram file invalid	Check telegram file: The file name has more than 8 characters or the file type is TEL, Tel or tel; or syntax error in telegram file.
14	Switich program file invalid	Check switch program file: The file name has more than 8 characters or the file type is not PRG, Prg or prg.
15	Wrong time zone sw. prog.	Check time zone configuration switch function.
16	Time source fail strat	Stratum of the current time source (DCF/GPS/NTP or internal time, in case of time source failure) too high → Check time source. Can also occur shortly after restart (approx. 10min) for a short time. → synch LED off
17	Time source fail TO	No time information from the source (GPS/DCF) for more than the timeout time configured → check time source. Configuration see chapter 6.5.14, menu 4: "Alarm delay for failure of the source"
18	No valid time	Set time manually, or configure, and/or check the time source. The RTC or the manually set time appears after restart without time information from the source.
19	NTP Synch lost	Synchronization lost. Check time source (DCF or NTP) and settings
20	Error bit20	Not used
21	NTP failed	NTP error → Check NTP configuration. As long as there is no DCF/GPS source: Set an NTP source (even if only one is available) to "prefer" (preferred source). Can also occur when reconfiguring time sources or time settings. After restarting the DTS 480x (< 30 min) the alarm can also occur.
22	Wrong time zone DCF in	Check time zone settings (time source).
23	Syn only diff too big	Check synchronization and source

24	No mail server	Check e-mail configuration. Observe file mailerror.txt in /ram/ for error correction.
25	SNMP not running	Check SNMP and trap configuration.
26	Error bit26	Not used
27	Error bit27	Not used
28	Line 2 current too high	Check MOBALine / Impulse line / DCF active line. Alarm disappears only, if alarm is removed. (Only active with DTS 4802 and DTS 4806)
29	Line 2 wrong time zone	Check time zone setting in (MOBALine / Impulse line) (Only active with DTS 4802 and DTS 4806)
30	Line 3 current too high	Check MOBALine / Impulse line / DCF active line. Alarm disappears only, if alarm is removed. (Only active with DTS 4806)
31	Line 3 wrong time zone	Check time zone setting in (MOBALine / Impulse line) (Only active with DTS 4806)
32	Line 4 current too high	Check MOBALine / Impulse line / DCF active line. Alarm disappears only, if alarm is removed. (Only active with DTS 4806)
33	Line 4 wrong time zone	Check time zone setting in (MOBALine / Impulse line) (Only active with DTS 4806)
34	Line 5 current too high	Check MOBALine / Impulse line / DCF active line. Alarm disappears only, if alarm is removed. (Only active with DTS 4806)
35	Line 5 wrong time zone	Check time zone setting in (MOBALine / Impulse line) (Only active with DTS 4806)
36	Line 6 current too high	Check MOBALine / Impulse line / DCF active line. Alarm disappears only, if alarm is removed. (Only active with DTS 4806)
37	Line 6 wrong time zone	Check time zone setting in (MOBALine / Impulse line) (Only active with DTS 4806)
38	Supply voltage high	Check the settings of the system voltage in menu "General". Check DC voltage (DC in) (Only active with DTS 4806).
39	Line 1 current too low	Check MOBALine / Impulslinie / DCF-Aktivlinie. Line current is lower than set minimum current. (Only active with DTS 4806)
40	Line 2 current too low	Check MOBALine / Impulslinie / DCF-Aktivlinie. Line current is lower than set minimum current. (Only active with DTS 4806)
41	Line 3 current too low	Check MOBALine / Impulslinie / DCF-Aktivlinie. Line current is lower than set minimum current. (Only active with DTS 4806)
42	Line 4 current too low	Check MOBALine / Impulslinie / DCF-Aktivlinie. Line current is lower than set minimum current. (Only active with DTS 4806)
43	Line 5 current too low	Check MOBALine / Impulslinie / DCF-Aktivlinie. Line current is lower than set minimum current. (Only active with DTS 4806)
44	Line 6 current too low	Check MOBALine / Impulslinie / DCF-Aktivlinie. Line current is lower than set minimum current. (Only active with DTS 4806)
45	Polarity Fault Battery	Check the connection of the external rechargeable battery (Bat In) (Only active with DTS 4806)
32-62	Error device 1-31	RS485 lines: Device error → for detailed error description see chapter 6.5.9. (Only active with DTS 4801)

D Troubleshooting

#	Error / Indication:	Possible case / Solution
1	sync LED is flashing:	DCF / GPS time source does not receive time → 2
2	Reception problem with DCF/GPS:	In menu <i>1 Status</i> → <i>4 Source</i> check, if DCF seconds-counter is counting up continuously from 0 – 59 (corresponding to the current second, value is updated about every 3 seconds. When counter is wrong → check receiver and cabling. Check "DCF In" LED on backside of the DTS masterclock.
3	No NTP time, despite of manual time setting → sync LED is off!	The local time source DCF/GPS or local has to be configured, otherwise NTP cannot set the time.
4	General time reception problem	If the time difference between DTS 480x.masterclock and the time source (NTP or DCF) is large (> 5 min), the NTP time synchronization may last quite long (> 30 min). To solve the problem, set the time manually.
5	DTS 480x.masterclock restarts all the time.	Check network configuration, Hostname has to be configured and Gateway has to be set (if no Gateway is available in the network, the own IP address of the DTS masterclock can be used as Gateway).
6	LAN LED (left side) is flashing orange.	No connection to the network. Check cabling.
7	Opening the menu via Telnet is not possible or DTS 480x.masterclock is not or no longer reachable via network.	Check network settings in menu <i>2 Configuration</i> → <i>5 Network</i> (only possible with serial connection): - IP-Address, Subnet mask and Gateway must be set correctly - Interface should be set to Auto - Check connection with "Ping" - When earlier the menu was not correctly exited (e.g. LAN cable removed), the menu can be blocked up to 15 minutes.
8	Update of the system software.	The system software can be updated by using FTP client software, MOBA-NMS or via a USB stick (see chapter 7). Your service office will advise you of the benefits and necessity of updates. The firmware file needed can be obtained from that office.
9	Information required to contact your MOBATIME service.	Device type, part number, production number and serial number: This details are given on the adhesive type label. The following files must be provided for the analysis: All files (in .zip folders, separate for each device) from the directories <i>/var/log</i> and <i>/etc/</i> . To copy this files use FTP, e.g. Windows file Explorer with ftp://[IP address], see chapter 8.7 or copy file to a USB stick (chapter 0). If the log files cannot be copied, read out the current software version: The software versions can be queried in the menu <i>1 STATUS/9 Software Versions</i> Place and date of purchase and of commissioning of the device. Most comprehensive possible details of the malfunction: Describe the problem, possible causes, measures taken, the system environment, etc.

E Serial Telegrams

E.1 General

A serial interface can be used in two different modes:

- Send out time of telegrams automatically (periodically)
- Receive command, send time telegram (on request)

Output modes

Auto Periodic transmission of a time telegram or a command at the end of a second, minute, hour, or at a max. of 6 programmable times of the day, or definable output – periodicity.

on request Telegram is transmitted on request. The 'request' strings can be defined.

The following requests are possible:

- stop output
- output telegram at once (singly)
- output telegram at the next second (singly)
- output every second / minute / hourly / daily or switch to auto-mode.

Telegram format

Any character sequence. Fill characters ASCII or binary.

Variable display: ASCII decimal, ASCII hexadecimal or binary. Different variables are assigned to strings in text tables (e.g. month: Jan, Feb..). Syntax for the telegram string analogous to the print command in the programming language "C". See chapter E.2 Syntax of the telegram configuration file.

Telegram time

The telegram always contains the time information for the "next" second for periodical telegram output. The telegram content is valid at the send time of the first character. The send time of the telegram can be shifted with the parameter TC (e.g. the standard IF 482 telegram valid at the end of the telegram).

The transmission time of a time telegram can be calculated with the following table. According to the transmission format set, the transmission time in ms for one character is read from the table and multiplied by the number of telegram characters:

parity stopp byte		7 data bits				8 data bits			
		none		odd/even		none		odd/even	
		1	2	1	2	1	2	1	2
ms per transmited byte									
300	bit/s	30.00	33.33	33.33	36.67	33.33	36.67	36.67	40.00
600	bit/s	15.00	16.67	16.67	18.33	16.67	18.33	18.33	20.00
1200	bit/s	7.50	8.33	8.33	9.17	8.33	9.17	9.17	10.00
2400	bit/s	3.75	4.17	4.17	4.58	4.17	4.58	4.58	5.00
4800	bit/s	1.88	2.08	2.08	2.29	2.08	2.29	2.29	2.50
9600	bit/s	0.94	1.04	1.04	1.15	1.04	1.15	1.15	1.25
19200	bit/s	0.47	0.52	0.52	0.57	0.52	0.57	0.57	0.63
38400	bit/s	0.23	0.26	0.26	0.29	0.26	0.29	0.29	0.31

Example:

9600 Bit/s, 8 data bits, none, 1 stop bit, the telegram has 20 characters.
Transmission time for the entire telegram:
 $20 \times 1.04 \text{ ms} = 20.8 \text{ ms}$

Name of the telegram file

The telegram file name is limited to 8 characters and its extension has to be TEL, Tel or tel, e.g. IF482Std.tel.

E.2 Syntax of the telegram configuration file

```
!TEL
    ;telegram type also !CTC or !MTS possible
;-- Start of the file (always on the first line) -----

;DEFINITIONS CONFIGURATION FILE FOR PRECISION MASTER CLOCK
;*****

;Customer:
;Date:
;Author:
;File:
;Interface:

;-- Output string -----
; the output string has a similar format to the print command in the
; programming language 'C'.
; !TS! - String with format information
; !TV! - Variables list in output sequence
; The formats and variables available can be seen below:
:
!TS!".....%d....%d..." ;String with Format information
!TV!var1,var2,..         ;Variables list

;-- Control and special characters
; " -> String beginning/end
; \" -> "
; \xFE -> h'FE (Byte binary)
; \\ -> \
; \n -> new line <CR> <LF> (h'0D h'0A)
; %% -> %
; %... -> Format information (see below)

;-- Possible formats:
;%dn ascii-dez where n=1/2/3/4 (number of decimal points, max. 3 places received)
; e.g. variable value d'40 => 40 @ n=2
; => 040 @ n=3
;%X ascii-hex
; e.g. variable value d'40 => 28
;%c char (binary)
; e.g. variable value d'40 => h'28
;%s string (always up to,(comma) see text tables
; e.g. string Jan, => Jan
;%b hex-output of an asciihex-string (always up to(comma)see
; text tables
; e.g. string 120A, => h'12 h'0A

;-- Possible variables:
;
;Name: Description: Range: Format:
;-----|-----|-----|-----
;
;MSE (Millisecond) (0..999) 1W
;HSE (Hundredth of a second) (0..99) 1B
;ZSE (Tenth of a second) (0..9) 1B
;SEK (Second) (0..59) 1B
;MIN (Minute) (0..59) 1B
;STD (12h or 24h format) (0..12)
; or(0..24) 1B (see !PM!)
;JAR (Year) (0..99) 1W
; or (1990..2089)
;MTG (Day of the month) (1..31) 1B
;JTG (Day of the year) (1..366) 1W
;WTG (Day of the week) (0..6) 1W Text table !WT!
; (Su..Sa)
;DOW (Day of the week) (0..7) 1B !DW!
;KAW (Calendar week) (1..53) 1B (according to Din ISO 8601)
;MON (Month) (1..12) 1W Text table !MO!
;MNT (Month) (1..12) 1B
;
;AMF (am/pm flag) (0/1) 1W Text table !AM!
;TMQ (synchronization qual.) (0..255
; or A..Z) 1B (see !TQ!)
;SAI (Season) (0..2) 1W Text table !SA!
; (Win/Sum/UTC)
;AKS (Season change (0/1) 1W Text table !AK!
; announcement)
;AMF (am/pm-Flag) (0/1) 1W Text table !AM!
;SST (Season status) (0..3) 1W Text table !ST!
```

```

;      (Bit 0 = Early warning bit)
;      (Bit 1 = Summer bit)
;SYA  (Synch. alarm)          (0/1)          1W Texttabelle !SY!
;      (0:synch ok, 1: synch alarm -> Alarm Nr.16, 17 or 19)
;CHS  (Check sum)            (0..255)      1B
;XCH  (XOR Check sum)        (0..255)      1B
;X1C  (XOR Check sum low nibble in ASCII) (0..9, A..F) 1B
;X2C  (XOR Check sum high nibble in ASCII)(0..9, A..F) 1B
;      Definitions:
;      CHS = (Sum of all bytes up to CHS) AND h'FF
;      XCH = XOR link of all bytes up to CHS

;e.g.  time telegram with following format (36 ASCII characters)
;
;      "Date: tt:mm:yy Time: hh:mm:ss,mmm<CR><LF>"
;
;      !TS!"Date: %d2:%s:%d2 time: %d2:%d2:%d2,%d3\n"
;      !TV!MTG,MON,JAR,STD,MIN,SEK,MSE
;-----

;-- Send offset automatic telegram output -----
!SO!hh:mm:ss!
;
;Send offset from midnight 00:00:00 at periodic time
;output (!CS!a!...).
;
;hh = hour ('00..23')
;mm = minute ('00..59')
;ss = second ('00..59')
;
;e.g.  the periodic time output should start at 06:00:00
;      in each case:
;
;      !SO!06:00:00!
;-----

;-- Interval automatic telegram output -----
!TI!p!hh:mm:ss!
;
;Interval from send offset of the periodic time output.
;
;s = every second
;m = every minute
;h = hourly
;d!hh:mm:ss! daily (max. 6 entries)
;p!hh:mm:ss! constant
;hh = hour ('00..23')
;mm = minute ('00..59')
;ss = second ('00..59')
;
;e.g.1 telegram output every second
;      !TI!s!
;
;e.g.2 telegram output daily at 13:00:00 hours
;      !TI!d!13:00:00!
;
;e.g.3: the interval of the periodic time output should be 5 seconds:
;      !TI!p!00:00:05!
;-----

;-- Hours format -----
!PM!
;Hours format 12h with am/pm flag
;without this entry: 24h format
;-----

;-- Synchronization mode -----
!TC!mmm!
;Pretiming of the telegram in ms (-90..995). To synchronize the telegram
;end with the second start the TC has to be set according to the telegram
;length and the transmission format. If TC is set, it will be performed.
;
;e.g.  Telegram start 120ms before the start of the second:
;      !TC!120!
;-----

```

```

;-- Format time quality -----
!TQ!MAX VALUE!STEP!
;If this entry is absent, the byte value of TMQ is
;outputted
;MAX VALUE corresponds to the byte value for 1
;MAX VALUE+STEP corresponds to the byte value for 2
;MAX VALUE+2*STEP corresponds to the byte value for 3 ...
;
;Example: Stratum 1 = A
;         Stratum 2 = B
;         Stratum 3 = C
;         ...
;
;         !TQ!1!1!
;-----

;-- Command Strings -----
!CS!n!l!"ss..."! or !CS!n!l!"ss..."!
;
;n = Number of the command ('2...9')
; n=2 Quit (no telegram output)
; n=3 Telegram output immediately(singly)
; n=4 Telegram output at the next second(singly)
; n=5 Telegram every second
; n=6 Telegram every minute
; n=7 Telegram hourly
; n=8 Telegram daily (-> entry: !TI!d!xx..)
; n=9 Output command (Request for external time source)
; n=a Telegram output periodic according to !TI!p! and !SO!
;
;l or l1 = Command length in bytes ('01...20')
; l=0 Command not active
;
;ss... Command string
; (max. 20 characters - must conform with 'l' or 'l1')
; Wildcards can be set with the '?' sign.
; This serves as wildcard for any character.
; Characters can also be outputted in AsciiHex format:
; e.g. \xFE d.h <FE>=(h'FE) is inserted
;      \\ d.h '\ ' is inserted
;
;e.g. Definition of a commando for immediate telegram
; output after a request (command n=3) :
; 'time<CR>' (characters l1=05)
; !CS!3!05!"time?"!
; !CS!3!5!"time\x0D"!
;-----

;-- Area for check sum calculation-----
!CK!aa,bb!
;aa = first character considered (telegram start position: 0)
;bb = last character considered + 1

;Missing !CK! in this case the check sum is formed via the whole telegram up to the
;check sum position.
;-----

;=====
;General info about the text tables:
; Name of the table: !xx!
; Separating character of the entries: , (comma)
; Maximal 16 characters pro Entry
; Warning: , do not forget(comma) after the last entry!
;=====

;-- Text table day of the week (WTG Su..Sa) 7 entries -----
!WT!Sunday,Monday,Tuesday,Wednesday,Thursday,Friday,Saturday,
;-----

;-- Weekday modus 1 entry -----
!DW!0..3
; 0 : 0 = Sunday, 1 = Monday,... 6 = Saturday
; 1 : 1 = Sunday, 2 = Monday,... 7 = Saturday
; 2 : 6 = Sunday, 0 = Monday,... 5 = Saturday
; 3 : 7 = Sunday, 1 = Monday,... 6 = Saturday
;-----

```

```

;-- Text table months (Jan..Dec) 12 entries -----
!MO!Jan, Feb, Mar, Apr, May, Jun, Jul, Aug, Sep, Oct, Nov, Dec,
;-----

;-- Text table season (Win, Sum, UTC) 3 entries -----
!SA!Win, Som, UTC,
;-----

;-- Text table season change announcement -----
;-- (no announcement, announcement) 2 entries
!AK!0,1,
;-----

;-- Text table season status -----
;-- (0 = no announcement, winter
;-- 1 = announcement, winter
;-- 2 = no announcement, summer
;-- 3 = announcement, summer) 4 entries
!ST!A,B,C,D,
;-----

;-- Text table AM/PM flag 2 entries -----
!AM!am, pm,
      ;1.Entry  AM/PM flag=0 d.h. 00:00..11:59
      ;2.Entry  AM/PM flag=1 d.h. 12:00..23:59
;-----

;-- Text table synchronization alarm 2 entries -----
!SY!ok, alarm,
      ;1.Entry  synchronization ok
      ;2.Entry  synchronization s-failure
;-----

;-- File End ---
!EE!

;-- Name of the file (optional) ----
@nnn...
      ;nnn...  File name, maximum 12 characters and a final
      ;        <CR>. The name can also be omitted, in this
      ;        case CTC 'NONAMEx.TEL' appears in the directory.
      ;
      ;IMPORTANT:
      ;        1) The name must stand AFTER the file end!EE!.
      ;
      ;        2) If a file with the same name is loaded on to the
      ;        CTC, such as one stored on the CTC, the stored one
      ;        will be OVERWRITTEN.
      ;
      ;
      ;e.g.      !EE!
      ;          @TELEDEF.TEL
      ;          ;last line
;-----

;last line (guarantees a <CR> after the file name)

```

F Copyright Notice

All rights of the software remain the property of Moser-Baer AG.

Existing software (OpenSource) with their own licences were partly used:

Designation	Description	Version	License	License Description (file)
U-Boot	Boot loader	2016.11	GPL version 2	COPYING
Linux	Operating system	4.9.76	GPL version 2	COPYING
Busybox	System environment	1.28.4	GPL version 2	LICENSE
NTP	NTP	4.2.8p10	Free	COPYRIGHT
pure-ftp	FTP server	1.0.47	Free, partly BSD	COPYING
NetSNMP	SNMP agent	5.7.3	BSD	COPYING
OpenSSL	SSL Lib.	1.0.2n	BSD style	LICENSE
OpenSSH	SFTP server	7.6.p1	BSD	LICENSE
dropbear	SSH server	v2017.75	MIT style: Free, party BSD	LICENSE
wide-dhcpv6	DHCPv6 client	20080615	Free	COPYRIGHT
flex	Flex Lib.	2.6.4	BSD adapted	COPYING
zlib	Compress lib.	1.2.11	Free	README
mailsend	E-mail client	1.19	GPL	COPYRIGHT

The complete license descriptions can be referred to in the file indicated in the respective original source code on the corresponding project page.

Licence text GPL, BSD and MIT:

GPL version 2: <http://www.gnu.org/licenses/gpl-2.0.html>

BSD: <http://www.opensource.org/licenses/bsd-license.php>

MIT <http://www.opensource.org/licenses/with-license.php>

The source code of the open source projects running under GPL can be requested from Moser-Baer AG (support@mobatime.com). Handling costs will be charged!

G Block diagram

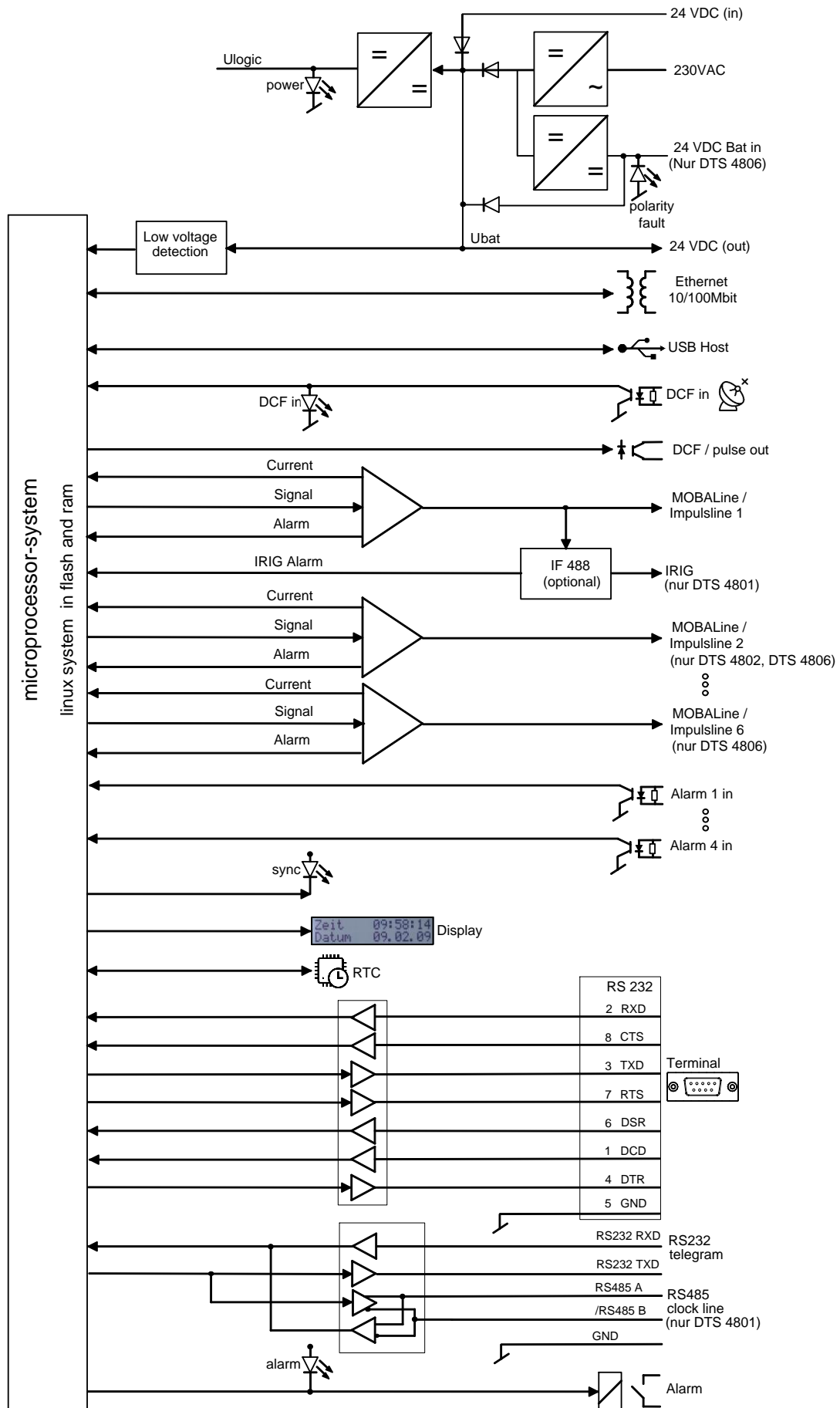

H Technical data

Dimensions	DTS 4801.masterclock, DTS 4802.masterclock, DTS 4803.masterclock 19" Rack, 1HE (H x W x D [mm]) = 44 x 483 x 125	
	DTS 4806.masterclock 19" Rack, 1HE (H x W x D [mm]) = 44 x 483 x 224	
Weight	DTS 4801, DTS 4802, DTS 4803.masterclock:	approx. 1.35 kg
	DTS 4806.masterclock (Standard):	approx. 3.5kg
	DTS 4806.masterclock 60V (Extended):	approx. 4kg
Ambient temperature	0 to 50°C, 10-90% relative humidity, without condensation	
Operation	Serial interface (via RS 232) or Telnet/SSH as well as MOBA-NMS (via LAN) In addition, operation is also possible with SNMP.	
Accuracy	GPS (DCF input) to NTP server:	typical < +/- 0.5ms
	DCF 77 radio receiver to NTP server:	typical < +/- 5ms ¹⁾
	NTP client to NTP server:	typical < +/- 0.5ms
	GPS (DCF input) or NTP client to clock line:	typical < +/- 0.5ms + accuracy of the clock line
	¹⁾ If necessary the DCF source has to be adjusted with an offset (see menu: <i>2 Local time source setting</i> → <i>3 DCF/GPS source correction</i>).	
	Important: NTP reception (DTS 480x as client and / or as server to external clients) can be influenced by the network traffic load and network devices (Hub, Switch, Router, Firewall...). If many clients request simultaneously, the typical accuracy may not be reached. Requirement for NTP accuracy: Poll interval: minimum 3, maximum 6.	
Time keeping (internal)	Synchronized with GPS:	+/-100 µs to UTC
Holdover (free run):	After at least 12 hours synchronization from the time source: at 20°C +/- 5°C:	< +/- 100 ms / day (< 1ppm) *
Generally:	During power break (based on internal RTC): at 20°C +/- 5°C:	< 5 ppm, but with jitter of +/- 15 ms * After a power failure the RTC time is available during at least 5 days (RTC buffered through a SuperCAP).
	*measured over 24 h	
Time server	NTP V4	(V3 compatible), (UDP), RFC 1305, RFC 5905 (Port 123) NTP Authentication with MD5 Key / Autokey
	SNTP	(UDP), RFC 2030 (Port 123)
	TIME	(TCP/UDP), RFC 868 (Port 37)
	DAYTIME	(TCP/UDP), RFC 867 (Port 13)
	Max. number of NTP and SNTP client requests: Typical: 3000 req. / sec. long term (with >99% req. answered) Max.: > 10'000 req. / s (short time, e.g. max. 1 minute) (e.g. request of clients once every 10 sec → >20'000 clients possible)	
	MTC-CAN-protocol for the communication with MTC Module CAN (only IPv4).	
NTP Mode	Server, Peer, Broadcast, Multicast	
NTP- slave clock lines	1 line with up to 15 different time zone entries. Communication through multicast or on IP request: - RFC 3376: Internet Group Management Protocol, Version 3 - RFC 1112: Host extensions for IP multicasting	

- RFC 4601: Protocol Independent Multicast - Sparse Mode (PIM-SM)
- RFC 3973: Protocol Independent Multicast - Dense Mode (PIM-DM)

Time zones (see App. B)	Up to 80 predefined, 20 programmable entries (PC Software Tool)		
Network interface	10BaseT / 100BaseTX (IEEE 802.3) Data transmission rate: Auto-negotiation / manual Connection: RJ-45 Only shielded cable is allowed.		
IP Configuration	DHCP, Static IP, IPv4, IPv6		
Network services	NTP	UDP, Port 123	see timeserver
	SNTP	UDP, Port 123	see timeserver
	TIME	TCP/UDP, Port 37	see timeserver
	DAYTIME	TCP/UDP, Port 13	see timeserver
	Telnet	TCP, Port 23	operation
	SSH	TCP, Port 22	operation
	SCP	über SSH	update
	SFTP	über SSH	update
	FTP	TCP, Port 21	update
	SNMP	UDP, Port 161	operation
		UDP, Port selectable (162)	alarm notification, see SNMP
	SMTP	TCP, Port selectable (25)	alarm mail see E-Mail
	DHCP	UDP, Port 68	dyn. address allocation (client)
	DNS	TCP/UDP, Port 53	address resolution (client)
	DHCPv6	only IPV6	
	ECHO	ICMP	“Ping“
SNMP	V2c, V3 with MD5 for authentication and DES for encryption (privacy).		
E-Mail	Alarm reporting via SMTP. Authentication at the mail server: - with sender address - with username/password SMTP-Auth with LOGIN, PLAIN (RFC 4954) or CRAM-MD5 (RFC 2195) no “POP before SMTP“		
Serial interface (front side)	D-Sub 9 (male): (RS232, 38400, 8, n, 1, no flow control) Cable length max. 3 m.		
Serial interface (back side)	Alternatively to RS485 clock line RS232 or RS485 (RS485 only in DTS 4801) Max. time deviation against internal time: +/- 10 ms, jitter < 10 ms 300-38400 Bauds, 7 or 8 Data bits, Parity: no, even, odd, Stop bit: 1 or 2, no flow control), cable length max. 3 m The description of the telegram functions is provided in Appendix E. NMEA 0183 without additional synch. pulse: ZDA telegram, 4800 bauds, 8, 1, none		
USB plug	USB Host for USB stick		
DCF Input	DCF receiver or DCF from GPS receiver (GPS 4500), current loop Timezone: selectable Nominal 28 VDC, max. 32mA, response threshold 8mA		
Alarm inputs	4 alarm inputs are available for the monitoring of external devices or as switch input for switch channels (daylight sensor) 18 – 36 VDC, max. 6 mA, close contact. External contact closed → no alarm. Cable length max. 30 m (not in the 3 m range of a catenary wire (railway)).		

MOBALine output	<p>Alternatively to the impulse clock line or DCF active line DTS 4801 / DTS 4803.masterclock: 1 line DTS 4802.masterclock: 2 lines: max. current = sum of both lines DTS 4806.masterclock: 6 lines Max. current: up to 700 mA eff. per line (except DTS 4802) Voltage: without load \approx 17 VAC, typical 15 VAC Line modes: 10 sec.-, ½ min.- or 1 min. steps Max. time deviation against internal time. +/- 10 ms MOBALine with switching function, switching function for clock illumination and World time function available. At least 28 VDC required</p>
Impulse line output	<p>Alternatively to the MOBALine clock line or DCF active line DTS 4801 / DTS 4803.masterclock: 1 line DTS 4802.masterclock: 2 lines: max. current = sum of both lines DTS 4806.masterclock: 6 lines Max. current: up to 1000 mA impulse current per line (exc. DTS 4802) Voltage: 24 VDC (polarized) (depending on power supply) Line modes: 1 min., ½ -min., 1/5-min., 1/8-min., 1 sec Impulse length: 200 – 30'000 ms, approx. 50 ms resolution Pause length: 200 – 30'000 ms, approx. 50 ms resolution Acceleration modes: 12 h, 24 h, 1 week Max. time deviation against internal time: +/- 1 ms At least 23.5 VDC power supply required</p>
DCF active line	<p>Alternatively to the MOBALine clock line or impusle clock line DTS 4801 / DTS 4803.masterclock: 1 line DTS 4802.masterclock: 2 lines: max. current = sum of both lines DTS 4806.masterclock: 6 lines Max. current: up to 1000 mA impulse current per line (exc. DTS 4802) Voltage: 24 VDC (polarized) (depending on power supply) Line modes: See diagramm in chapter 6.5.5. Max. time deviation (pulse start) against internal time: +/- 1 ms At least 23.5 VDC power supply required</p>
IRIG-B output	<p>Only DTS 4803 (part no.: 133688):</p> <p>Line mode: IRIG-B122, IRIG-B Std 12h (B122), IRIG-B123, IRIG-B DIEM AFNOR A, AFNOR C, DCF-FSK IRIG-B126 (127)</p> <p>Output voltage ($R_L=50$ Ohm): 0.1 – 5.5 Vpp (configurable) SNR_{dB}: typical \geq 40dB Impedance: $R_i < 50 \Omega$</p>
DCF / pulse output	<p>DCF time code or pulse output selectable. Passive current loop $U_{max} = 30$ VDC, $I_{on} = 10..15$ mA, $I_{off} < 1$ mA @20VDC Cable length max. 30 m (not in the 3 m range of a catenary wire (railway)). DCF output: time zone selectable Pulse mode: second, minute, hour, user defined interval: 1-3600sec. Pulse length: 20 – 500 ms, jitter pulse length: +/- 2 ms Max. time deviation against internal time: +/- 1 ms, jitter first pulse edge < 0.5 ms</p>

RS 485 line output	(Only DTS 4801). Alternatively to serial telegrams Number of monitored clocks: max. 31 Max. time deviation against internal time: +/- 10 ms, jitter < 10 ms Communication RS485, 19200, 8, n, 1, no flow control, MOBA-RS485-protocol
Alarm contact	Opening relay contact (alarm active → contact open). Switching load: 30 W (125 VDC or 1 A), e.g. 1 A @ 30 VDC or 60 VA (150 VAC or 1 A), e.g. 0.5 A @ 120 VAC
Alarm reporting / Error messages	Alarm contact see Alarm contact E-Mail see E-Mail SNMP-Notification see SNMP-Trap Display see Display Alarm LED -
Display	DTS 4801.masterclock: 2 lines with up to 16 characters DTS 4802.masterclock: 2 lines with up to 16 characters DTS 4803.masterclock: 2 lines with up to 16 characters DTS 4806.masterclock: 2 lines with up to 20 characters for the displaying of status information.
DC power supply	DTS 4801.masterclock, DTS 4802.masterclock, DTS 4803.masterclock: 24 - 28 VDC / 1.5 A (28 V required for MOBALine) DTS 4806.masterclock 24 - 72 VDC / 6.3A (28 V required for MOBALine)
Mains power supply	DTS 4801.masterclock, DTS 4802.masterclock, DTS 4803.masterclock: 90 - 240 VAC / 50 - 60 Hz / max. 30 VA Typical: < 5 VA @ 230 VAC (without external load) DTS 4806.masterclock (Standard): 100 - 240 VAC / 50 - 60 Hz / max. 200 W DTS 4806.masterclock 60V (Extended): 100 - 240 VAC / 50 - 60 Hz / max. 400 W
External battery unit	Type: gas-proof lead-acid battery Nominal voltage: 24VDC Load: trickle-charging by the DTS 4806 max. charge current: 500 mA Deep discharge protection switches off battery at 19 VDC.
Power supply output	Nominal 28 VDC, max. 400 mA

I Index

A

Accuracy	115
AFNOR	32
Alarm Configuration	56
Alarm input	46, 96
Alarm input – techn. data	116
Alarm list	104
Alarm mask	46, 56, 57, 59, 64, 96
Alarm recording	23, 56
Alarm relay	56
Alarm relay – techn. data	118
Alarm status	15, 23, 56
Authentication	58, 85
Autoconf	63
Autokey	53, 54, 87

B

Baudrate	19, 38
Baudrate – PC connection	97
Block diagram	114
Broadcast NTP	53

C

Cable – PC connection	97
CAN monitoring with MTC	55
Channel program	95
Channel relay	44
Channel relay after start-up	96
Community (SNMP)	88
Configuration	26
Configuration – save	78
Connection Table (to be filled-in)	121
Connections – Front	97
Connections – alarm relay	98, 99, 100
Connections – DCF & GPS	101
Connections – PC	97
Connections – rear view	98, 99, 100
Control input	46, 96
Control Key	54
Copyright	113
Correcting time manually	55
CRAM-MD5	58

D

Data bit	19, 38
Daylight Saving Time	103
DAYTIME	85, 116
DC power supply	98, 99, 100, 118
DCF active	33, 34
DCF impulse	35, 37
DCF input	98, 99, 101
DCF output	37, 101
DCF receiver – connection	101
DCF-Impulse-Output	36
DHCP	62
DHCPv6	63
Display	15

DST	103
DTS Extension	98, 99, 100

E

E-Mail	57
E-Mail – techn. data	116
Error messages	104

F

Factory settings	70
Firmware	15, 23
Fix stratum	81
Front connections	97
FTP	77, 116
FTP-Tools	77

G

GPS 4500 – connection	101
-----------------------	-----

I

Impulse line	30
Interface	107
IPv4	62
IPv6	63
IPv6 – FTP connection	77
IRIG-B	32

K

Key	53, 54, 85
-----	------------

L

Leap second	49, 85
LED display front view	14
LED display rear view	14
Line current	23
Line time	23
Lines	27
Linux	19
Local time source	81
Login (Menu)	18

M

Mains power supply	118
Mains supply	98, 99, 100
Manual time set	55
mbs3-file	79
MD5	86
Menu Login	18
Menu structure	20
MIB Files	88
Minimum current	28, 30, 33, 35
MOBALine	28
MOBA-NMS	12
Multicast	42, 115
Multicast address	51
Multicast NTP	53
Multicast with NTP time source	81

N

Network configuration	61
Network information	23
Network services	116
NMEA	116
NTP	85, 116
NTP as backup time source	51, 84
NTP Authentication	54, 85
NTP Autokey	87
NTP Broadcast	53
NTP Multicast	53
NTP server	51
NTP slave clocks	42, 115
NTP symmetric keys	85
NTP time source	52
NTP time take-over	81
NTP Version	85
ntp.keys	54
NTP-Modus	115
ntpq	24

O

Operation (Menu)	18
Operation (SNMP)	89

P

Parity	19, 38
Password	7, 18
Password configuration	60
Port	42, 57, 60
Power reserve	71, 72
Program file	44, 70, 79, 95
Pulse output	37, 98, 99, 101

R

Request Key	54
RS 485 line	39
RTC	84, 115
RTC (Real Time Clock)	80

S

Satellites	25
SCP	78, 116
SCP-Tools	78
Season table	102
Security - network	7
Serial connection	19
Serial interface – techn. data	116
Serial telegrams	38, 107
Service – Required Information	106
Set language	60
SFTP	12, 77, 116
SFTP-Tools	77
SMTP	57, 116
SNMP	12, 88, 116
SNMP – alarm notification	94
SNMP – alive notification	94
SNMP – notification	89
SNMP – variables	91
SNMP access configuration	67
SNMP configuration	59, 64

SNMP operation	89
SNMP traps	59, 89
SNMP user configuration	66
SNTP	85, 116
Software Update	74, 75
Software version	15, 23
Spring terminals	101
SSH	19, 116
Start-up	96
Status menu	23
Stop bit	19, 38
Stratum	24, 49
Sunrise time – calculated	45
Sunset time – calculated	45
Switch function	44, 95
Switch input	46, 96
Switch program	44
Switch program – signal	95
SwitchEditor	79, 95
System voltage	69, 71

T

Telegram file	38, 70, 79, 107
Telegram file – name	108
Telnet	19, 116
Terminal	18
Terminals	98, 99, 100, 101
TIME	85, 116
Time administration	80
Time handling	48
Time server	85, 115
Time servers in the Internet	84
Time source	25
Time source – Configuration	50
Time status	24
Time zone	102
Time zone for displayed time	60
Time zone selection	68
Time zone server	42
Time zone table	102
Transmission time	107
Trap	59, 89
Troubleshooting	106
Trusted Key	54
ttl (time to live)	53
Twilight	45, 47
Twilight function – priority	96

U

Update – Software	74, 75
Update time zone table	103
USB	70, 75, 76, 79
UTC	80, 103

V

Version	15, 23
---------	--------

W

Week program	95
World time	29, 42
World Time Function	29

*Headquarters/Production
Sales Worldwide*

MOSEER-BAER AG | Spitalstrasse 7 | CH-3454 Sumiswald
Tel. +41 34 432 46 46 | Fax +41 34 432 46 99
moserbaer@mobatime.com | www.mobatime.com

Sales Switzerland

MOBATIME AG | Stettbachstrasse 5 | CH-8600 Dübendorf
Tel. +41 44 802 75 75 | Fax +41 44 802 75 65
info-d@mobatime.ch | www.mobatime.ch

MOBATIME SA | En Budron H 20 | CH-1052 Le Mont-sur-Lausanne
Tél. +41 21 654 33 50 | Fax +41 21 654 33 69
info-f@mobatime.ch | www.mobatime.ch

Sales Germany/Austria

BÜRK MOBATIME GmbH
Postfach 3760 | D-78026 VS-Schwenningen
Steinkirchring 46 | D-78056 VS-Schwenningen
Tel. +49 7720 8535 0 | Fax +49 7720 8535 11
buerk@buerk-mobatime.de | www.buerk-mobatime.de